

STANUM[®]

The New Floor Spring



Price List

Architectural **Hardware** Solutions



LAKSHMI FLOAT GLASS LTD.

Lakshmi Float Glass Limited, is the leading glass distribution company in the country. We had our humble beginning in 1969 & over the last 50 years, we have been recognised for our honesty and service.

Providing the best quality products has been the hallmark of LFGL.

It is our firm belief that customer satisfaction is the key to successful business. We have a well - established distribution and service network across India.

This enriching journey has helped LFGL develop a deep understanding of customer's requirements. To take our services further, LFGL has brought together a team to cater the customer's Glass Hardware requirements through a wide range of high-quality products.

The house of LFGL brings world class products and complete solutions in glass hardware with the finest quality & technology under the brand name STANUM.

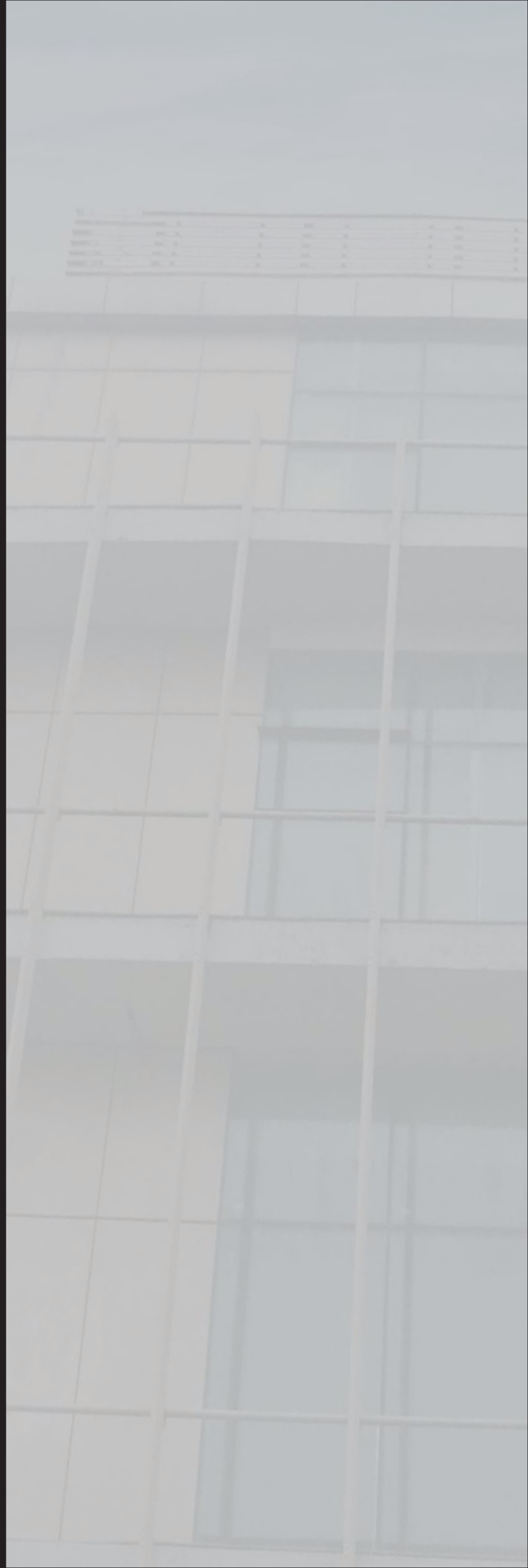



STANUM[®]

The New Floor Spring

Brand "STANUM" is defined by a singular intent to elevate customer delight, adhering to the central tenet of Reliability, performance & after sales

For you to stay ahead.

Team STANUM is cruised forward by technically adept professionals with a passion to serve people better, emphasising equally on product quality and service. What's more, with complete customer support at every step, extending from selection to installation and after-sales service.

For you to have peace of mind.

Enterprise STANUM comes from the house of Lakshmi Float Glass, comprising professionals who have led and catapulted the glass industry ahead, while being determined to usher in impeccable quality, originality and ease of use.

For you to look nowhere else.

Innovative STANUM is focused on subjecting breakthroughs to stringent lab tests and certified to Global Standards which ensures that the product is the perfect answer to the lofty visions of architects, builders, consultants and contractors who seek distinction beyond excellence.

For you to fulfill your interior dreams.

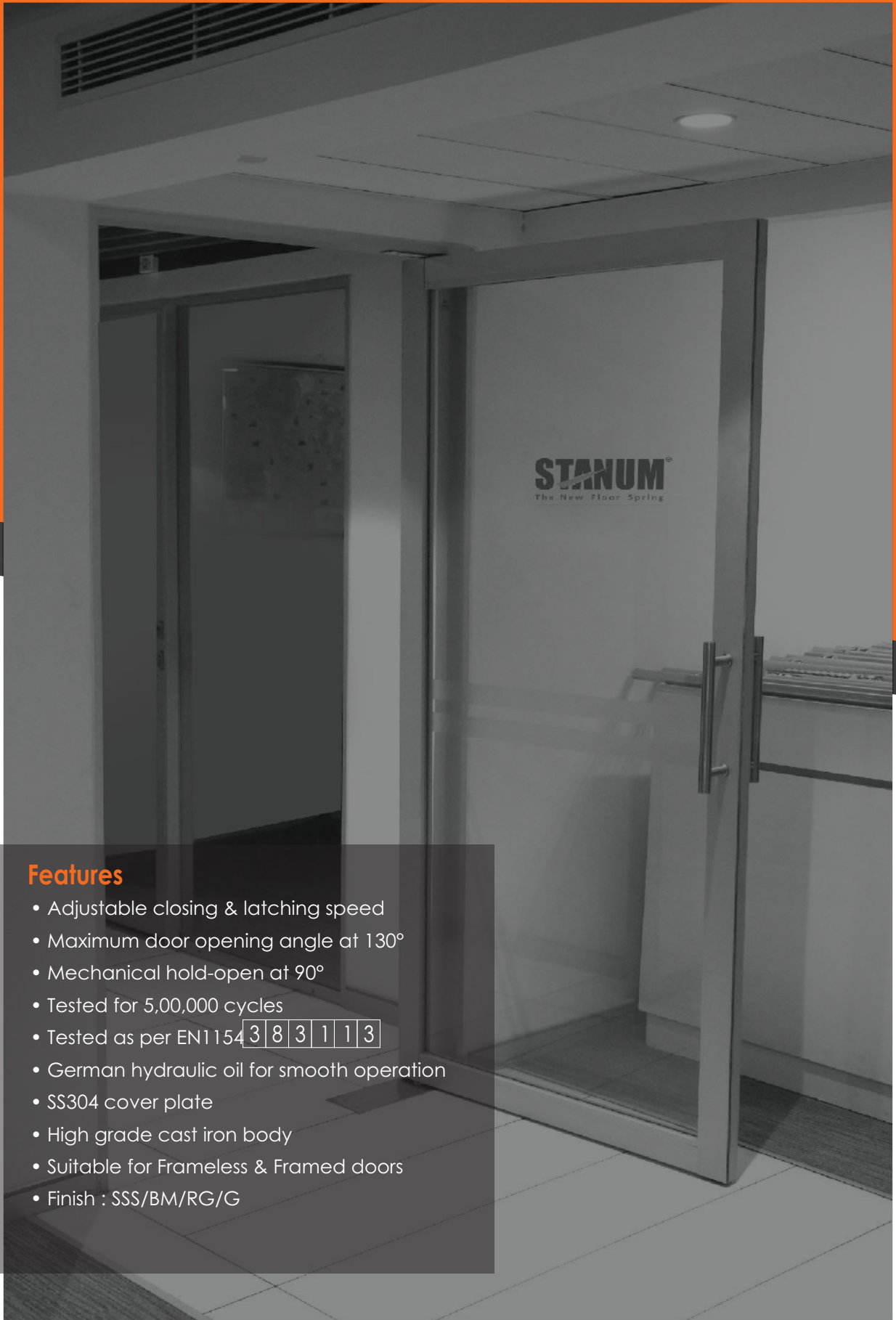

Features

- Adjustable closing & latching speed
- Maximum door opening angle at 130°
- Mechanical hold-open at 90°
- Tested for 5,00,000 cycles
- Tested as per EN1154

3	8	3	1	1	3
---	---	---	---	---	---
- German hydraulic oil for smooth operation
- SS304 cover plate
- High grade cast iron body
- Suitable for Frameless & Framed doors
- Finish : SSS/BM/RG/G

HFS-103

Double Cylinder Floor Spring

- Max. Door Width 1050 mm
- Max. Door Weight 90 kg

2 YEARS
WARRANTY

intertek
Tested Quality Assured

CE
CERTIFIED

Tested for
500,000
Cycles



HFS-103-BM
MRP:- 7680/-

HFS-103-RG
MRP:- 8000/-

HFS-103-G
MRP:- 8000/-



MRP:- 7000/-

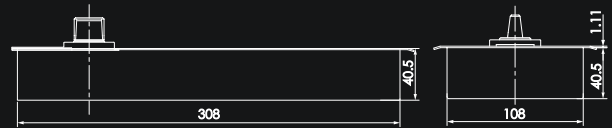

HFS-124

Double Cylinder Floor Spring

- Max. Door Width 1150 mm
- Max. Door Weight 120 kg

2 YEARS
WARRANTY

intertek
Tested Quality Assured

CE
CERTIFIED

Tested for
500,000
Cycles



HFS-124-BM
MRP:- 7980/-

HFS-124-RG
MRP:- 8300/-

HFS-124-G
MRP:- 8300/-



MRP:- 7200/-

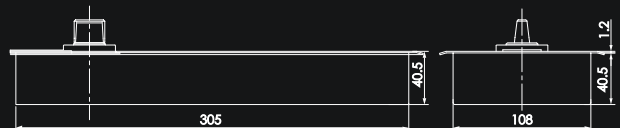

HFS-154

Double Cylinder Floor Spring

- Max. Door Width 1250 mm
- Max. Door Weight 150 kg

2 YEARS
WARRANTY

intertek
Tested Quality Assured

CE
CERTIFIED

Tested for
500,000
Cycles

MRP:- 7850/-

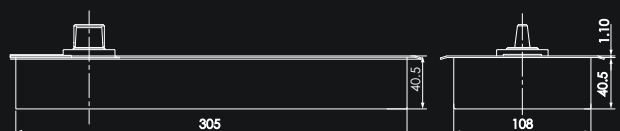

HFS-204

Double Cylinder Floor Spring

- Max. Door Width 1500 mm
- Max. Door Weight 270 kg



MRP:- 15150/-

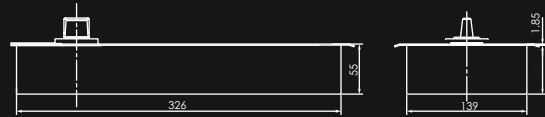
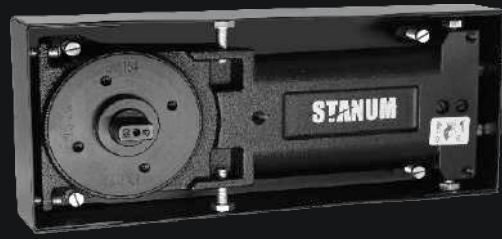

HFS-502

Single Cylinder Floor Spring

- Max. Door Width 700 mm
- Max. Door Weight 50 kg



MRP:- 2800/-



HFS-602

Single Cylinder Floor Spring

- Max. Door Width 800 mm
- Max. Door Weight 60 kg



MRP:- 3100/-

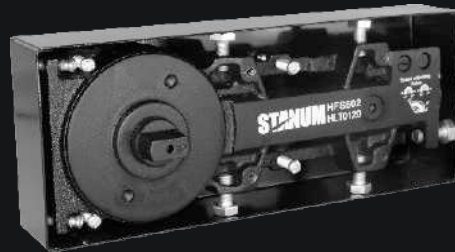

HFS-702

Single Cylinder Floor Spring

- Max. Door Width 900 mm
- Max. Door Weight Up To 70 kg



MRP:- 3700/-



HFS-802

Single Cylinder Floor Spring

- Max. Door Width 1000 mm
- Max. Door Weight 80 kg

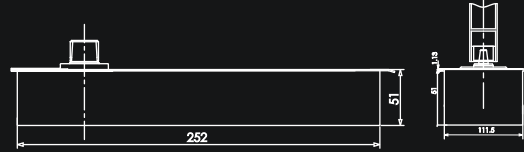
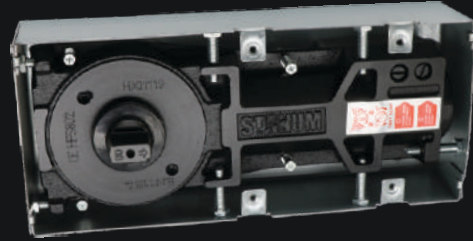

MRP:- 4250/-

HFS-360

Single Cylinder 360° Floor Spring

- Max. Door Width 1500 mm
- Max. Door Weight 100 kg

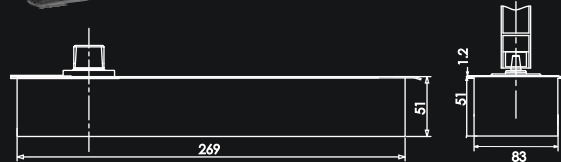

MRP:- 24500/-

FSA-01

Accessories for Framed / Wooden Doors

MRP:- 750/-

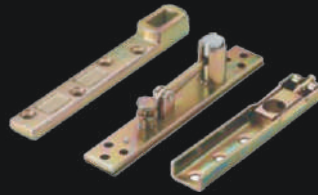

Range Summary

DOUBLE CYLINDER

SINGLE CYLINDER

Product Characteristics	HFS-103	HFS-124	HFS-154	HFS-204
Door Weight	90Kg	120Kg	150Kg	270Kg
Door Width	1050 mm	1150 mm	1250 mm	1500 mm
Dimension Wall to Spindle	65 mm	65 mm	65 mm	65 mm
Latching Speed (Adjustable)	✓	✓	✓	✓
Closing Speed Continuously Adjustable)	✓	✓	✓	✓
Hold Open 90 degree	✓	✓	✓	✓
Din Left DIN right	✓	✓	✓	✓
Door Opening Angle	130°	130°	120°	120°
Tested to EN1154	✓	✓	✓	✓
Certification	CE CERTIFIED	✓	✓	✓
warranty	intertek 2 YEARS WARRANTY	✓	✓	✓
Corrosion Testing - 96 Hrs.	✓	✓	✓	✓
Cycles tested - 5 Lakh	✓	✓	✓	✓

Product Characteristics	HFS-502	HFS-602	HFS-702	HFS-802	HFS-360
Door Weight	50Kg	60Kg	70Kg	80Kg	100Kg
Door Width	700 mm	800 mm	900 mm	1000 mm	1500 mm
Dimension Wall to Spindle	65 mm	65 mm	65 mm	65 mm	65 mm
Latching Speed (Adjustable)	✓	✓	✓	✓	✓
Closing Speed Continuously Adjustable)	✓	✓	✓	✓	✓
Hold Open 90 degree	✓	✓	✓	✓	✓
Din Left DIN right	✓	✓	✓	✓	✓
Door Opening Angle	115°	115°	115°	115°	360°
Tested to En 1154 Compliance	✓	✓	✓	✓	✓
Certification	CE CERTIFIED	✓	✓	✓	✓
warranty	intertek 1 YEARS WARRANTY	✓	✓	✓	✓
Corrosion Testing - 96 Hrs.	✓	✓	✓	✓	✓
Cycles tested - 5 Lakh	✓	✓	✓	✓	✓

HYDRAULIC PATCH

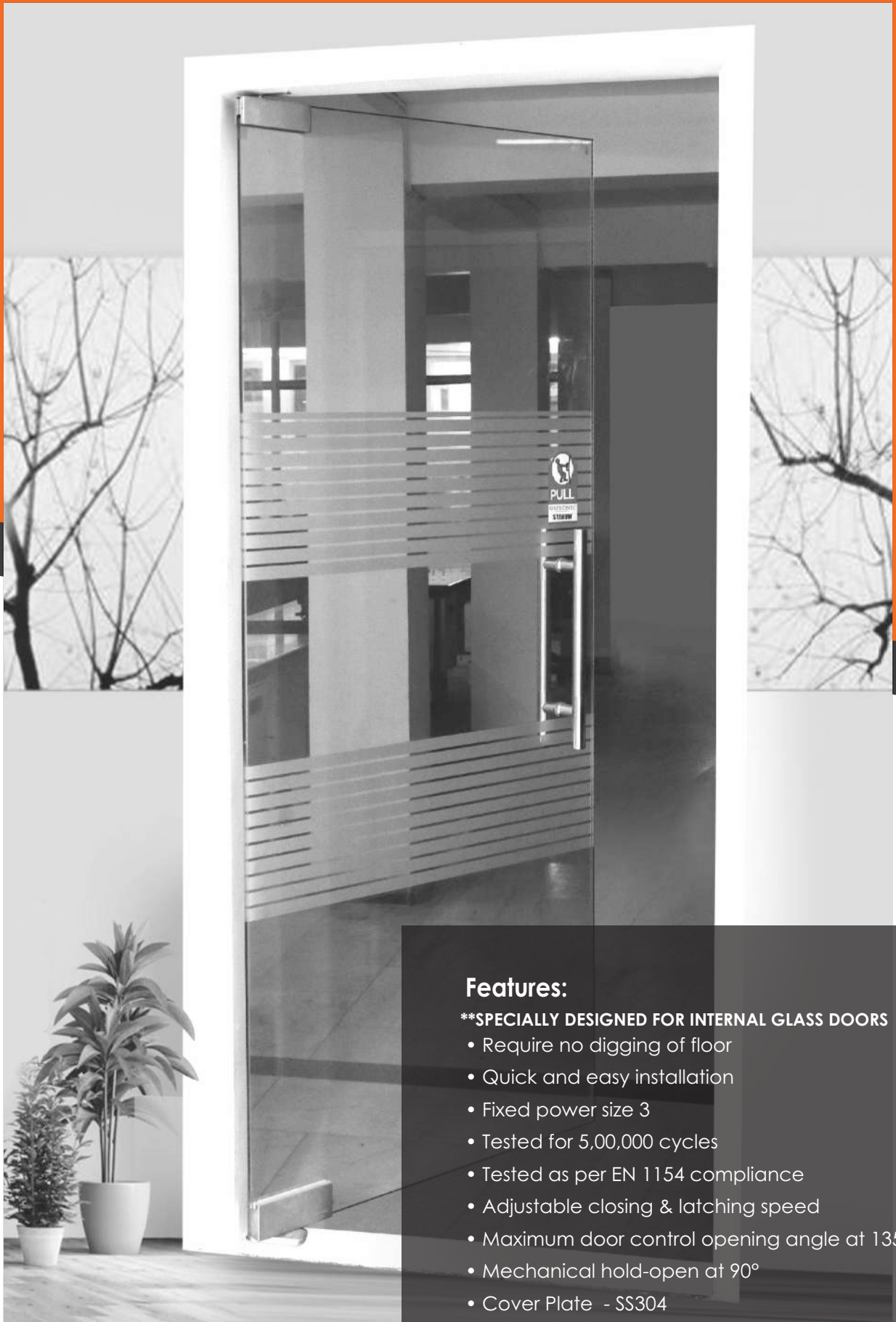

Features:

**SPECIALLY DESIGNED FOR INTERNAL GLASS DOORS

- Require no digging of floor
- Quick and easy installation
- Fixed power size 3
- Tested for 5,00,000 cycles
- Tested as per EN 1154 compliance
- Adjustable closing & latching speed
- Maximum door control opening angle at 135°
- Mechanical hold-open at 90°
- Cover Plate - SS304

HHP-080

Hydraulic Patch

- Max. Door Width 900 mm
- Max. Door Weight 80 kg
- Glass Thickness 8-12 mm
- Finish Satin Stainless Steel



HHP-080-BM



2 YEARS //
WARRANTY

HHP-080 - MRP:- 8620/-
HHP-080-BM - MRP:- 8800/-

HHP-090

Hydraulic Patch

- Max. Door Width 1000 mm
- Max. Door Weight 100 kg
- Glass Thickness 8-12 mm
- Finish Satin Stainless Steel



HHP-090-BM



2 YEARS //
WARRANTY

HHP-090 - MRP:- 9410/-
HHP-090-BM - MRP:- 9500/-

HPF-2115-SN

Top Patch for Hydraulic Patch

- Specially designed for hydraulic Bottom patch
- Finish Satin Stainless Steel
- Glass Thickness 8-12 mm

MRP:- 1830/-



HHP-80-W

Hydraulic Patch with Accessories - Wooden door

- Max. Door Width 950 mm
- Max. Door Weight 80 kg
- Finish Satin Stainless Steel
- Door Thickness ≥ 42 mm

MRP:- 9500/-

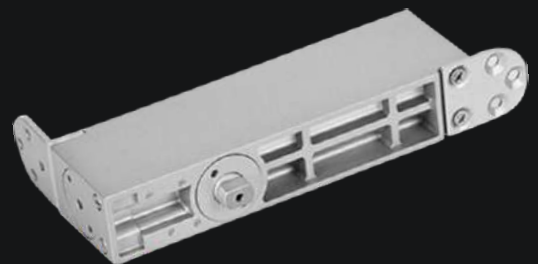



Features

- Cover Plate: SS304 for better corrosion resistance
- With high grade internal aluminium body for durable performance
- Strong pivot and spindle insert
- Special cover design for better locking system
- Finish SN | BM | RG | G

HPF-2101-SN

Over Panel Side Connecting
Patch with pivot (Big L)

Area of application:
To fix top glass panel & side glass
panel for frameless glass door fittings



MRP:- 2270/-



HPF-2101-BM

MRP:- 2520/-

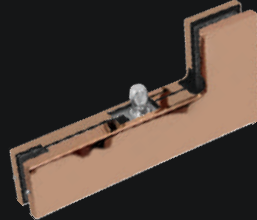

HPF-2101-RG

MRP:- 2630/-

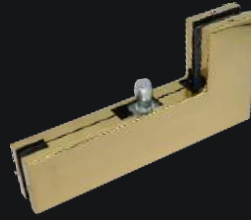

HPF-2101-G

MRP:- 2630/-

HPF-2102-SN

Top Patch

Area of application:
Top patch for frameless glass
door fittings



MRP:- 1460/-



HPF-2102-BM

MRP:- 1620/-



HPF-2102-RG

MRP:- 1690/-

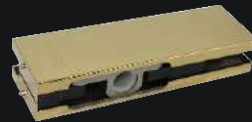

HPF-2102-G

MRP:- 1690/-

HPF-2103-SN

Bottom Patch

Area of application:
Bottom patch for frameless glass door fittings

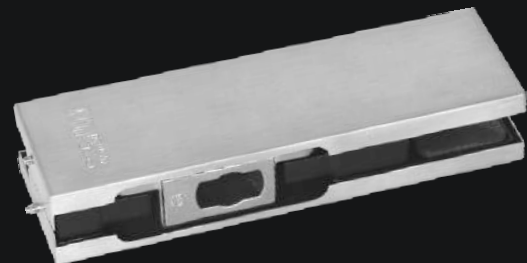

MRP:- 1460/-



HPF-2103-BM

MRP:- 1620/-



HPF-2103-RG

MRP:- 1690/-



HPF-2103-G

MRP:- 1690/-

HPF-2104-SN

Wall Mounted Over Panel
Patch with Pivot

Area of application:
To fix over panel patch with wall

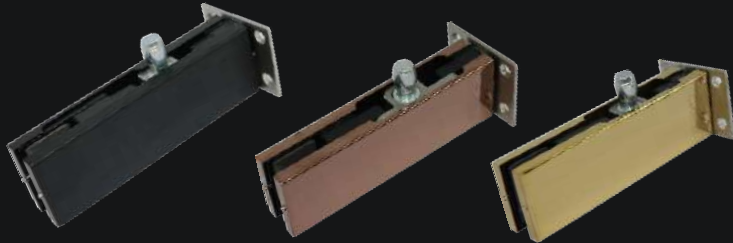

HPF-2104-BM

MRP:- 1860/-

HPF-2104-RG

MRP:- 1940/-

HPF-2104-G

MRP:- 1940/-



MRP:- 1680/-

HPF-2105-SN

Over Panel Side Connecting Patch (Small L)

Area of application:
To fix top glass panel & side glass panel for frame
less glass door fittings



HPF-2105-BM

MRP:- 1800/-

HPF-2105-RG

MRP:- 1880/-

HPF-2105-G

MRP:- 1880/-



MRP:- 1620/-

HPF-2106-SN

Corner Patch with stopper

Area of application:
To fix top glass panel and side glass panel
with stopper for frameless glass door fittings

MRP:- 1350/-



HPF-2107-SN

Quadruple Connecting Patch

Area of application:
To fix four glass to glass panel at
center of fixed structure

MRP:- 2110/-



HPF-2108-SN

Double Glass Connecting Patch with Fin Fitting Inside

Area of application:

To connect 2 glasses in perpendicular shape with fin

MRP:- 2270/-



HPF-2109-SN

Wall to Glass Connecting Patch

Area of application:

To fix single glass panel with fixed structure

MRP:- 760/-



HPF-2110-SN

Glass to Glass Connecting Patch

Area of application:

To connect two glasses

MRP:- 1070/-



HPF-2111-SN

Double Glass Connecting Patch With Fixed Structure

Area of application:

To fix two glass panels with fixed structure

MRP:- 810/-



HPF-2112-SN

Top Pivot for Patch/Point Fitting Doors

Area of application: Top pivot for frameless glass door fittings

MRP:- 300/-



HPF-2112-BM

MRP:- 360/-

HPF-2112-RG

MRP:- 450/-

HPF-2112-G

MRP:- 450/-

HPL-2113-SN

Corner Patch Lock

Area of application:

- Bottom patch lock for frameless glass doors
- With euro profile brass cylinders
- Supplied with Four high security brass keys



MRP:- 2000/-



HPL-2113-BM

MRP:- 2410/-



HPL-2113-RG

MRP:- 2500/-



HPL-2113-G

MRP:- 2500/-

HPF-2114-R-SN

Over Panel Side Connecting Patch with Fin (Right)

Area of application:

To fix top glass panel & side glass panel patch with right fin

MRP:- 4860/-

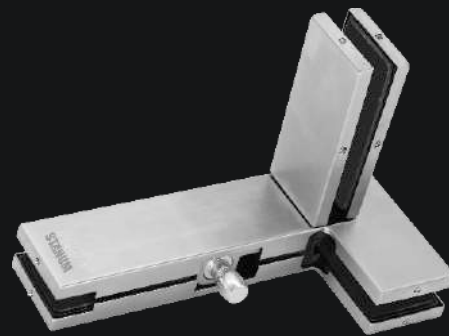

HPF-2114-L-SN

Over Panel Side Connecting Patch with Fin (Left)

Area of application:

To fix over glass panel & side glass panel patch with left fin

MRP:- 4860/-

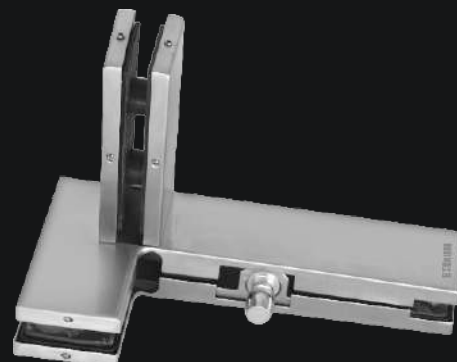

SHOWER CUBICLE FITTINGS



- Material SS304
- Available Finish PSS/SSS/BM/RG/G
- For Glass Thickness 08-12 mm
- Max. Door Width 800 mm
- Max. Door Weight 40 kg per pair
- Max. Door Weight 45 kg per pair (PVD Hinges)

Features:

- High corrosion resistance for durable performance
- Protective screw cap for prevention of water seepage
- Gaskets to prevent glass damage
- Bevelled & Straight design available

HSH-3102-BV

Wall to Glass Hinge 90° (Double Side)

- Area of application: For connecting wall to glass hinge at 90°

MRP:- 2190/-



HSH-3103-BV

Glass to Glass Hinge 90°

- Area of application: For connecting glass door panel with fixed glass panel at 90°

MRP:- 4125/-

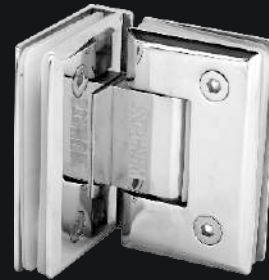

HSH-3104-BV

Glass to Glass Hinge 180°

- Area of application: For connecting glass door panel with a fixed glass panel at 180°

MRP:- 3700/-



HSH-3105-BV

Glass to Glass Hinge 135°

- Area of application: For connecting glass door panel with a fixed glass panel at 135°

MRP:- 3820/-



HSH-3106-BV

Wall to Glass Bracket 0°

- Area of application: For connecting fixed glass panel with wall

MRP:- 2250/-



HSB-3107-BV

Glass To Glass "T" Shower Hinge
Double Action Three Way

- Area of application: Double Door with fix Glass at 90°

MRP:- 7850/-

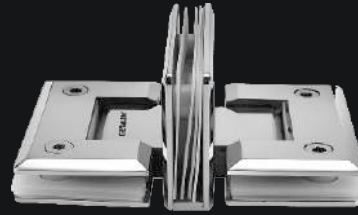

HSB-3020-ST

Wall to Glass Hinge 90° (Double Side)

- Area of application: For connecting wall to glass hinge at 90°



HSB-3020-BM

MRP:- 2580/-



HSB-3020-RG

MRP:- 3200/-



HSB-3020-G

MRP:- 3200/-



MRP:- 2040/-

HSB-3030-ST

Glass to Glass Hinge 90°

- Area of application: For connecting glass door panel with fixed glass panel at 90°



HSB-3030-BM

MRP:- 4410/-



HSB-3030-RG

MRP:- 4650/-



HSB-3030-G

MRP:- 4650/-



MRP:- 3700/-

HSB-3040-ST

Glass to Glass Hinge 180°

- Area of application: For connecting glass door panel with a fixed glass panel at 180°



HSB-3040-BM

MRP:- 3890/-

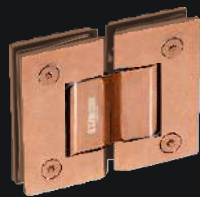

HSB-3040-RG

MRP:- 4500/-



HSB-3040-G

MRP:- 4500/-



MRP:- 3450/-

HSB-3050-ST

Glass to Glass Hinge 135°

- Area of application: For connecting glass door panel with fixed glass panel at 135°

MRP:- 3570/-



HSB-3060-ST

Wall to Glass Bracket 0°

- Area of application: For connecting fixed glass panel with wall



HSB-3060-BM

MRP:- 2210/-



HSB-3060-RG

MRP:- 2470/-



HSB-3060-G

MRP:- 2470/-



MRP:- 2030/-

HSB-3070-ST

Glass To Glass "T" Shower Hinge
Double Action Three Way

- Area of application: Double Door with fix Glass at 90°



HSB-3070-BM

MRP:- 8500/-



HSB-3070-RG

MRP:- 8750/-



HSB-3070-G

MRP:- 8750/-

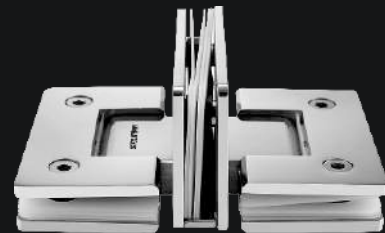

MRP:- 7630/-

GLASS CONNECTORS

- Material SS304
- Available Finish PSS/SSS/BM/RG/G
- Glass Thickness 8-12 mm
- Connector Thickness
 - PSS/SSS 03 mm
 - BM/RG/G 04 mm (Casting)

Features:

- Suitable for highly corrosion resistant weather requirement
- Firm grip with glass panel
- With gasket to prevent glass damage



HGC-4101

Wall to Glass Connector 0°

- Area of application: For fixing glass panels with wall or floor



HGC-4101-BM

MRP:- 710/-



HGC-4101-RG

MRP:- 800/-



HGC-4101-G

MRP:- 800/-



MRP:- 330/-

HGC-4102

Wall to Glass Connector 90°

- Area of application: For fixing glass panels with wall or floor at 90°angle



HGC-4102-BM

MRP:- 940/-



HGC-4102-RG

MRP:- 1100/-



HGC-4102-G

MRP:- 1100/-



MRP:- 310/-

HGC-4103

Glass to Glass Connector 90°

- Area of application: For fixing two glass panels at 90°angle



HGC-4103-BM

MRP:- 1120/-

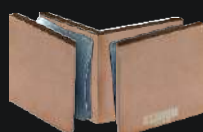

HGC-4103-RG

MRP:- 1470/-

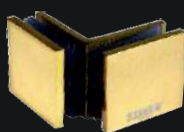

HGC-4103-G

MRP:- 1470/-



MRP:- 410/-

HGC-4104

Wall to Glass Connector 180°

- Area of application: For fixing glass panels with wall at 180° angle



HGC-4104-BM

MRP:- 910/-

HGC-4104-RG

MRP:- 1100/-

HGC-4104-G

MRP:- 1100/-



MRP:- 340/-

HGC-4105

Glass to Glass Connector 180°

- Area of application: For fixing two glass panels at 180° angle



HGC-4105-BM

MRP:- 1015/-

HGC-4105-RG

MRP:- 1460/-

HGC-4105-G

MRP:- 1460/-



MRP:- 410/-

HGC-4107

Glass to Glass Connector 135°

- Area of application: For fixing two glass panels at 135° angle

MRP:- 410/-



HGC-4108

Three Way Glass Connector

- Area of application: For fixing 3 glass panels

MRP:- 1110/-



HPH-5105-TB-D

Towel Bar with Handle (Ø19 mm)

- Area of application: Handles for shower glass door
- Size : 476 x 171mm



HPH-5105-TB-BM
MRP:- 3415/-

HPH-5105-TB-RG
MRP:- 3700/-

HPH-5105-TB-G
MRP:- 3700/-

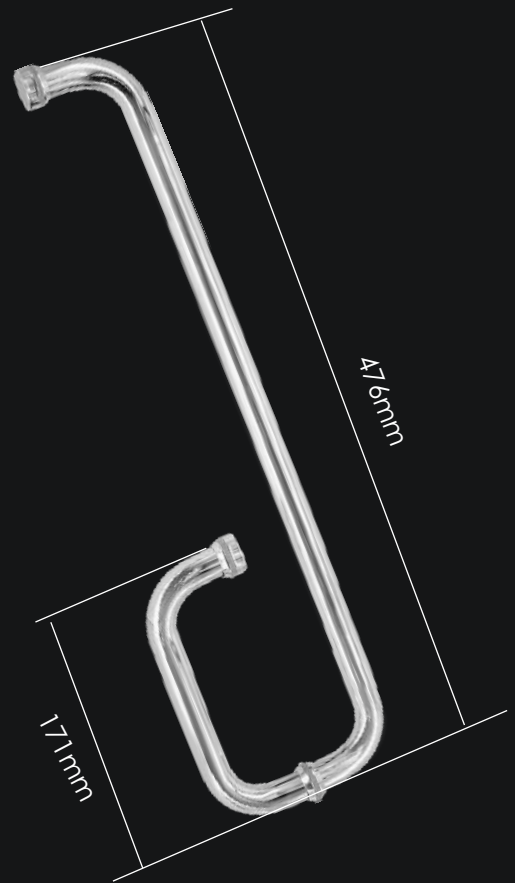

MRP:- 1535/-

HPH-5106-TB-D

Towel Bar with Handle (Ø19 mm)

- Area of application: Handles for shower glass door
- Size : 469 x 169mm

MRP:- 1535/-

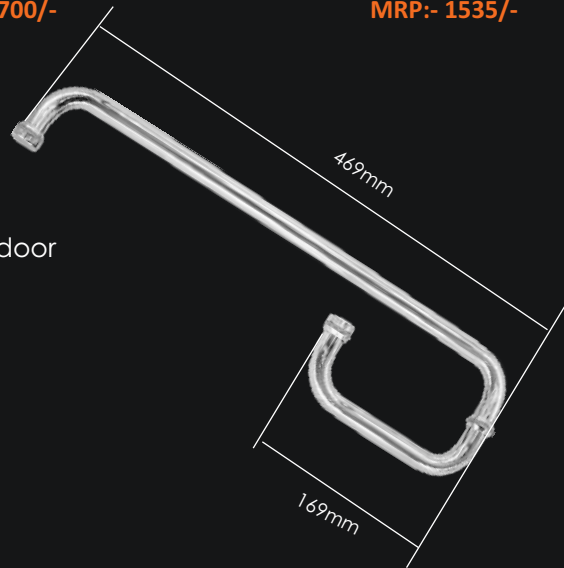

HSA-01

Shower Header Wall Socket

- Area of application: To join reinforcing pipe with wall for shower cubical fitting



HSA-01-BM
MRP:- 800/-



HSA-01-RG
MRP:- 875/-



HSA-01-G
MRP:- 875/-



MRP:- 460/-

HSA-02

Shower Header Wall Socket for 135°

- Area of application: To support reinforcing pipe with glass and firm grip with panel

MRP:-865/-



HSA-03

Shower Header Support Clamp

- Area of application: To support reinforcing pipe with glass and firm grip with panel



HSA-03-BM
MRP:- 860/-



HSA-03-RG
MRP:- 960/-



HSA-03-G
MRP:- 960/-



MRP:- 535/-

HSA-04

Shower Header Support Clamp for End Caps

- Area of application: To support reinforcing pipe with glass and firm grip with panel



HSA-04-BM
MRP:- 870/-



HSA-04-RG
MRP:-975/-



HSA-04-G
MRP:- 975/-



MRP:- 575/-

HSA-05

Shower Header Clamp for Two Way Connecting Rod

- Area of application: To join reinforcing pipes at adjustable angle
- Adjustable to any angle



HSA-05-BM
MRP:- 1200/-



HSA-05-RG
MRP:- 1390/-



HSA-05-G
MRP:- 1390/-



MRP:- 865/-

HSA-06

Shower Header Clamp for Three Way Connecting Rod

- Area of application: Clamps to join three reinforcing pipes
- Non adjustable angle



MRP:- 810/-



HSA-06-BM

MRP:- 1215/-



HSA-06-RG

MRP:- 1345/-



HSA-06-G

MRP:- 1345/-

HSR-07

Reinforcing Rod

Thickness - 1.5 mm
 Length (PSS / SSS) - 2 Mtr., 3 Mtr.
 Length (BM/RG/G) - 2 Mtr.,



HSR-07-BM	2 Mtrs. ₹3410
HSR-07-G	2 Mtrs. ₹3520
HSR-07-RG	2 Mtrs. ₹3520
HSR-07-PSS	2 Mtrs. ₹1620
HSR-07-SSS	2 Mtrs. ₹1620
HSR-07-SSS	3 Mtrs. ₹2320
HSR-07-PSS	3 Mtrs. ₹2320

HDK-07

- Area of application: Shower glass door knob
- Hole Diameter 10 mm

MRP:- 990/-

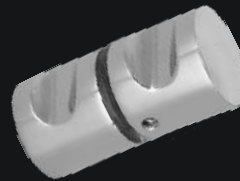

HDK-08

- Area of application: Shower glass door knob
- Hole Diameter 10 mm

MRP:- 990/-

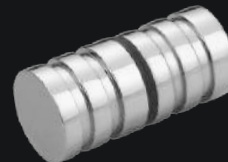

HDK-09

- Area of application: Shower glass door knob
- Hole Diameter 10 mm

MRP:- 990/-

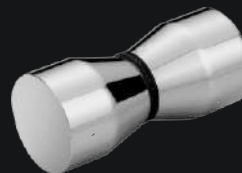

HDK-10

- Area of application: Shower glass door knob
- Hole Diameter 10 mm

MRP:- 990/-



GLASS SLIDING SYSTEM

- Material SS304
- Finish Satin Stainless Steel
- Track I Anodized Aluminium



HDSL-C301

•Weight - 80 kg



Floor guide (1pcs)

MRP:- 5110/-



Stopper (2pcs)



Adjustment tool (1pcs)



Roller for glass door (2pcs)

HDSL-C401

•Weight - 40 kg



Floor guide (1pcs)

MRP:- 4470/-



Stopper (2pcs)



Handle (1 pcs)



Roller for glass door (2pcs)

HDSL-T1

Specifications .

- Aluminum Anodized
- Track for Single/Double Door.
- Available in 2mtr and 4mtr.



2 Mtr. - MRP:- 3630/-
4 Mtr. - MRP:- 7260/-

HDSL-T3

Specifications .

- Aluminum Anodized
- Track for Door and Fixed Glass .
- Available in 2mtr and 4mtr.

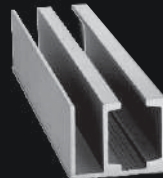

2 Mtr. - MRP:- 4080/-
4 Mtr. - MRP:- 8165/-

HSDA-01-SSS

Sliding Door Accessories
Glass to Track fixer

MRP:- 595/-



HSDA-03-SSS

Sliding Door Accessories
Wall to Track fixer

MRP:- 810/-

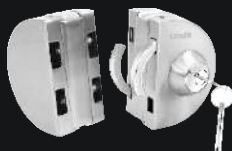

HGDL-104

MRP:- 2100/-



HSDH-01-SSS

MRP:- 1350/-



HSDH-02-SSS

MRP:- 1460/-

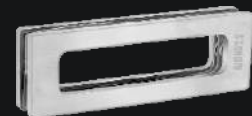

HSDH-03-SSS

MRP:- 1750/-



HSSL-A101-PSS

MRP:- 6500/-



HSSL-A101-RG

MRP:- 8500/-



HSSL-A101-BM

MRP:- 7500/-



HSSL-A101-G

MRP:- 8500/-

S.no	Shower Sliding Screen Components	Qty
01	Roller	2 pcs
02	Track To Glass Holder	2 pcs
03	Stopper	2 pcs
04	Floor Guide	1 pcs
05	Wall To Track Connector	2 pcs
06	Sliding Door Handle	1 pcs
07	Adjustable Knob (Track to Roller)	2 pcs

- Weight 65 kg
- Track 2 Mtr.
- Material SS304
- Glass Thickness 8 -12 mm
- Clear Opening 950 mm
- Door Height 2280 mm



HSSL-Track-01-BM

MRP:- 4500/-

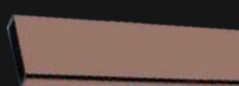

HSSL-Track-01-RG

MRP:- 5200/-



HSSL-Track-01-G

MRP:- 5200/-



HSSL-Track-01-PSS

MRP:- 3800/-

HDSL-C501

- Weight 50 kg
- Glass Thickness 8-10mm
- Glass Height 2100 MM
- Glass Width 950 MM

MRP:- 10320/-

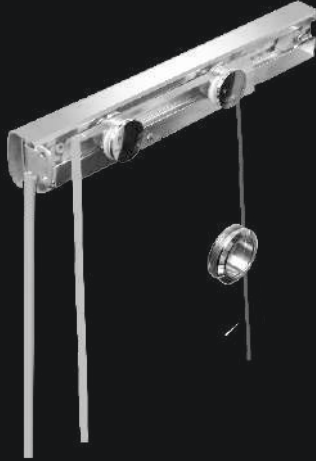





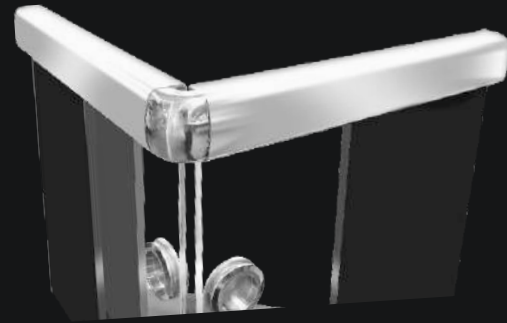

HDSL-C601

- Weight 50 kg (each)
- Glass Thickness 8-10mm
- Glass Height 2100 MM
- Glass Width 950 MM (Each)

MRP:- 20870/-

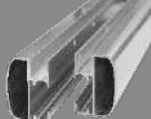

S.no	SHOWER SLIDING SCREEN COMPONENTS		C501	C601
01		SLIDING DOOR WHEEL	2 Pcs.	4 Pcs.
02		WALL MOUNTING BRACKET	2 Pcs.	4 Pcs.
03		FLOOR GUIDE	1 Pcs.	2 Pcs.
04		STOPPER WITH COLLISION AVOIDANCE	2 Pcs.	4 Pcs.
05		TRACK CORNER JOINT	NA	1 Pcs.
06		ALUMINIUM TOP TRACK	1 Pcs. (2Mtr.)	2 Pcs. (2Mtr.)
07		ROUND HANDLE	1 Pcs.	2 Pcs.
08		ACCESSORIES	1 Pcs.	2 Pcs.

SEAL STRIPS

Seal Strips - 2.2 Mtr (Glass Thickness-8mm to 10 mm)

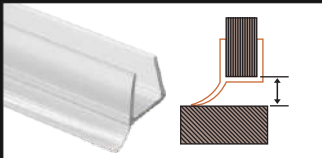

SSP-01 Wall Seal / Bottom Seal

MRP:- 260/-

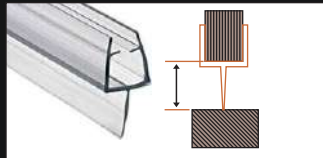

SSP-02 Central Seal

MRP:- 260/-

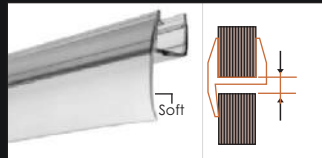

SSP-04 Central Weather Seal 180°

MRP:- 260/-

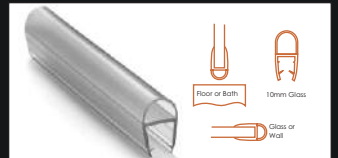

SSP-08 Central Weather D Seal 180°

MRP:- 260/-



SSP-09M Magnetic Seal 180°

MRP:- 960/-

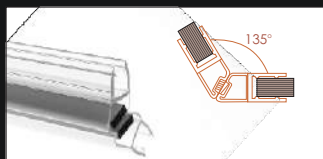

SSP-10M Magnetic Seal 135°

MRP:- 960/-



SSP-11M Magnetic Seal 90°

MRP:- 960/-



SSP-14 Offset Lip seal

MRP:- 260/-

Seal Strips - 2.2 Mtr (Glass Thickness-10 mm) available in - BM

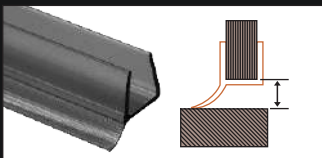

SSP-01 Wall Seal / Bottom Seal

MRP:- 330/-

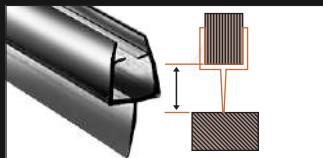

SSP-02 Central Seal

MRP:- 330/-

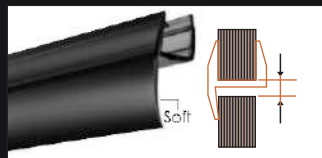

SSP-04 Central Weather Seal 180°

MRP:- 330/-



SSP-08 Central Weather D Seal 180°

MRP:- 330/-



SSP-09M Magnetic Seal 180°

MRP:- 1210/-

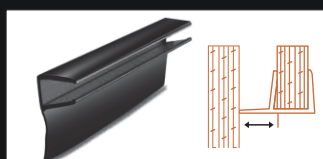

SSP-14 Offset Lip seal

MRP:- 330/-

Seal Strips - 3 Mtr



SSP-15 Brush seal (Central Seal)
Available in 10mm & 12mm

MRP:- 700/-



SSP-16 Brush seal (Side Seal)
Available in 10mm & 12mm

MRP:- 700/-



SSP-17 D Seal
Available in 12mm

MRP:- 370/-

DOOR HANDLE



Features:

- Firm positioning for opening glass door
- Application: Handles for glass door
- Glass Thickness 08 - 12 mm

GLASS DOOR HANDLES

Glass Door Handle H-Type

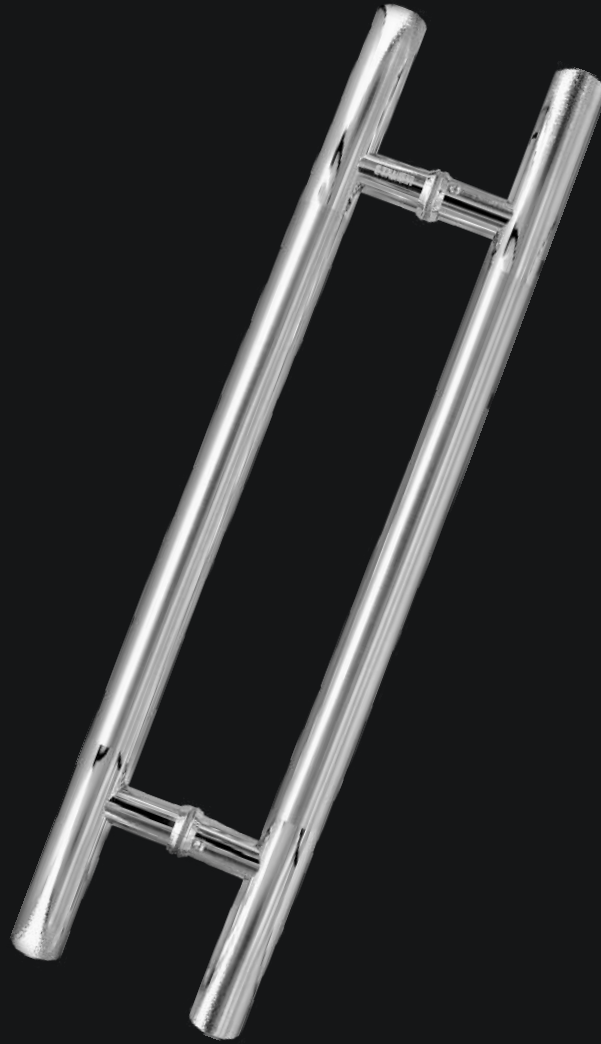

Model No	Handle Diameter	Length	Center to Center	Hole Diameter in glass	Finish	Price
HPH-5101	32 mm	457 mm	305 mm	14 mm	Mid Brush & SSS	MRP-1500/-
HPH-5108	25 mm	300 mm	212 mm	14 mm	SSS	MRP-1390/-
HPH-5109	25 mm	457mm	305 mm	14 mm	SSS	MRP-2030/-
HPH-5110	25 mm	600 mm	400 mm	14 mm	SSS	MRP-2250/-
HPH-5113	32 mm	600 mm	400 mm	14 mm	Mid Brush & SSS	MRP-2050/-
HPH-5114	32 mm	900 mm	600 mm	14 mm	Mid Brush & SSS	MRP-2550/-
HPH-5115	32 mm	1200 mm	900 mm	14 mm	Mid Brush & SSS	MRP-3050/-
HPH-5119	25 mm	300 mm	201 mm	14 mm	PSS & SSS	MRP-1390/-
HPH-5120	32 mm	600 mm	450 mm	14 mm	SS	MRP-2300/-

GLASS DOOR HANDLES

Glass Door Handle D-Type



Model No	Handle Diameter	Length	Center to Center	Hole Diameter in glass	Finish	Price
HPH-5103	25 mm	325 mm	300 mm	14 mm	PSS & SSS	MRP- 1510/-
HPH-5104	19 mm	171 mm	152 mm	14 mm	PSS & SSS	MRP- 1390/-
HPH-5111	25 mm	450 mm	425 mm	14 mm	PSS & SSS	MRP- 1560/-
HPH-5112	32 mm	600 mm	568 mm	14 mm	PSS & SSS	MRP- 1850/-
HPH-5116	32 mm	337 mm	305 mm	14 mm	PSS	MRP- 1650/-
HPH-5117	32 mm	632 mm	600 mm	14 mm	PSS	MRP- 1990/-
HPH-5118	25 mm	600 mm	575 mm	14 mm	SSS	MRP- 1750/-

GLASS DOOR HANDLES

Glass Door Pull Handle with Lock

HPHL-5107

- Available Finish SSS | PSS
- Length 1230 mm
- Handle Dia. 25 mm
- Lock Point Dia. 25 mm
- Attachment Point Dia. 14 mm
- Center to Center 990 mm

MRP:- HPHL-5107- SSS & PSS - 17350/-



GLASS DOOR HANDLES

Glass Door Pull Handle with Lock

HPHL-5122

- Available Finish BM | Gold | SSS
- Length 1500 mm
- Center to Center 1125 mm
- Handle Dia. 35 mm
- Lock Point Dia. 25 mm

MRP:- HPHL-5122- SS - 17950/-

MRP:- HPHL-5122-BM- 24350/-

MRP:- HPHL-5122-Gold- 25350/-





HPH-5121-MB

32mm x 450mm x 305mm

MRP:- 1870/-

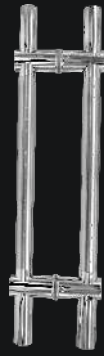

(Adjustable Handle)

HPH-5130-SS

25mm x 457mm x 305mm

MRP:- 2950/-



(Adjustable Handle)

HPH-5131-SSS

32mm x 600mm x 400mm

MRP:- 3550/-



HPH-5132-PS

32mm x 600mm x 400mm

MRP:- 2950/-



HPH-5133-MB

32mm x 600mm x 400mm

MRP:- 2550/-



HPH-5134-SS

32mm x 600mm x 575mm

MRP:- 4150/-



HPH-5135-MB

32mm x 600mm x 400mm

MRP:- 2550/-



HPH-5136-ST

32mm x 600mm x 560mm

MRP:- 4650/-

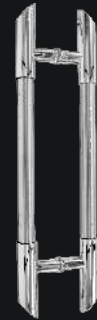

HPH-5137-ST

38mm x 600mm x 400mm

MRP:- 3650/-



HPH-5138-ST

32mm x 600mm x 400mm

MRP:- 2600/-



HPH-5139-MB

32mm x 600mm x 400mm

MRP:- 3300/-



HPH-5109-BM

25mm x 457mm x 305 mm

MRP:- 2900/-



HPH-5109-RG

25mm x 457mm x 305mm

MRP:- 3100/-



HPH-5109-G

25mm x 457mm x 305mm

MRP:- 3100/-



HPH-5140-G

32mm x 457mm x 305mm

MRP:- 4250/-



HPH-5140-RG

32mm x 457mm x 305mm

MRP:- 4250/-



HPH-5140-PSS

32mm x 457mm x 305mm

MRP:- 3950/-



HPH-5140-BM

32mm x 457mm x 305mm

MRP:- 4100/-



HPH-5142-BM

30mm x 1200mm x 900mm

MRP:- 4650/-



HPH-5141-SSS

25mm x 457mm x 305mm

MRP:- 3700/-



HPH-5141-PSS

25mm x 457mm x 305mm

MRP:- 3800/-



HPH-5141-BM

25mm x 457mm x 305mm

MRP:- 4000/-

GLASS DOOR LOCKS



Features:

- Operates with one side key and one side knob
- Euro profile cylinder
- Supplied with high security brass keys

HGDL-104

- Quick and easy installation
- Finish : Satin
- Glass thickness : 8-12 mm
- No Cutout Required In Glass
- One Side Key One Side Knob



With Strike Plate

MRP:- 2100/-

MRP:- 2000/-



HGDL-104-BM
MRP:- 2350/-



HGDL-104-RG
MRP:- 2600/-



HGDL-104-G
MRP:- 2600/-

HGDL-105

- Quick and easy installation
- Finish : Satin
- Glass thickness : 8-12 mm
- No Cutout Required In Glass
- One Side Knob



MRP:- 1250/-

HGDL-106

- Quick and easy installation
- Finish : Satin
- Glass thickness : 8-12 mm
- No Cutout Required In Glass
- One Side Key One Side Knob



With Strike Plate

MRP:- 1700/-

MRP:- 1600/-

HGDL-108

- Quick and easy installation
- Finish : Satin
- Glass thickness : 8-12 mm
- No Cutout Required In Glass
- One Side Key One Side Knob
- For Double Door's



MRP:- 1600/-

With Strike Plate

MRP:-1220/-

HGDL-109

- Finish : Satin
- Glass thickness : 8-12 mm
- Cutout required in glass
- One Side Key One Side Knob
- For Double Door's



With Strike Plate

MRP:- 7180/-

MRP:-6470/-

SPIDER FITTINGS



Features:

- SS316
- Teflon and PVC Gaskets
- With Fin and Without Fin

HSP-6101-SSS

ONE WAY FIN SPIDER FIXING WITH CEILING/WALL

Features:

- One way fin spider fixing with ceiling for vertical support.
- To join single glass panel with ceiling/wall.
- Teflon washers to prevent damage to glass with 2 SS fasteners

MRP:-2320/-



HSP-6102-SSS

TWO WAY FIN SPIDER FIXING WITH CEILING/WALL

Features:

- Two way fin spider 90° fixing with ceiling/wall for vertical support.
- To join 2 glass panels assembly with ceiling.
- Teflon washers to prevent damage to glass with 2 SS fasteners.

MRP:- 2865/-



HSP-6103-SSS

TWO WAY FIN SPIDER

Features:

- Two way fin spider 180°.
- To join 2 glass panels assembly with glass fin.
- Teflon and PVC washers/gaskets to prevent damage to glass.

MRP:- 4590/-

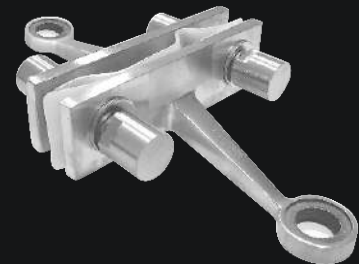

HSP-6104-SSS

FOUR WAY FIN SPIDER

Features:

- Four way fin spider.
- To join 4 glass panels assembly with glass fin.
- Teflon and PVC washers/gaskets to prevent damage to glass.

MRP:- 5670/-

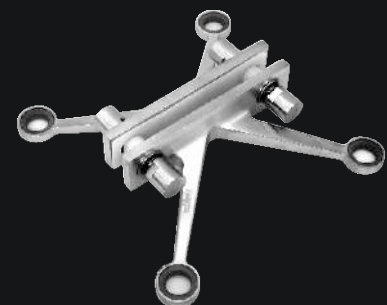

HSP-6105-SSS

ONE WAY WITHOUT FIN SPIDER FITTING

Features:

- One way spider fitting
- To join glass at one point without fin
- To be used with HSP-6114-SSS for joining with a fixed structure.

MRP:- 2760/-



HSP-6106-SSS

TWO WAY WITHOUT FIN SPIDER FITTING AT 180° ANGLE

Features:

- Two way spider fitting at 180° angle.
- To join two glasses without fin at 180°.
- To be used with HSP-6114-SSS for joining with a fixed structure.

MRP:- 3950/-



HSP-6107-SSS

TWO WAY WITHOUT FIN SPIDER FITTING AT 90° ANGLE

Features:

- Two way spider fitting at 90°.
- To join two glasses without fin at 90° angle.
- To be used with HSP-6114-SSS for joining with a fixed structure.

MRP:- 4590/-



HSP-6108-SSS

THREE WAY WITHOUT FIN SPIDER FITTING

Features:

- Three way spider fitting.
- To join three glasses without fin.
- To be used with HSP-6114-SSS for joining with a fixed structure.

MRP:- 5240/-



HSP-6109-SSS

FOUR WAY WITHOUT FIN SPIDER FITTING

Features:

- Four way spider fitting.
- To join four glasses without fin.
- To be used with HSP-6114-SSS - for joining with a fixed structure.

MRP:- 5560/-



HSP-6110-SSS

FIXED BOLT FOR FLAT HEAD

Features:

- Flat head routil.
- Used to attach spider fitting with glass.
- Teflon washers/gaskets to prevent damage to glass.
- Adjustable up to 21 mm thickness of glass.

MRP:- 1080/-



HSP-6111-SSS

ARTICULATED BOLT FOR FLAT HEAD

Features:

- Flat head articulated routel.
- Used to attach spider fitting with glass.
- Teflon washers/gaskets to prevent damage to glass.
- Adjustable upto 13.52 mm glass thickness.

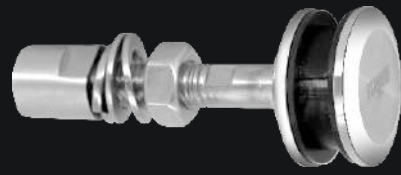

MRP:- 1780/-

HSP-6112-SSS

FIN PLATE - 300 MM

Features:

- Fin plate 300 mm.
- To join glass fin with ceiling or floor.
- Three Hole to grip glass
- Teflon and PVC washers/gaskets to prevent damage to glass.
- Flat base to join strongly with floor or ceiling.
- Made from Certified Stainless steel grade 304 for superior rust prevention.



MRP:- 10260/-

HSP-6113-SSS

SPLICE PLATE - 300 MM

Features:

- Splice plate 300 mm.
- To join two pieces of glass fin together.
- Three point joining of fin.
- Teflon and PVC washers/gaskets to prevent damage to glass.
- Made from Certified Stainless steel grade 304 for superior rust prevention.

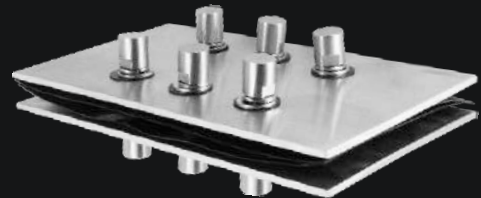

MRP:- 9400/-

HSP-6114-SSS

CONNECTOR TO JOIN WITHOUT FIN SPIDER FITTING

- Connector to join without fin spider fittings with fixed structure.
- Made from Certified Stainless steel grade 304 for superior rust prevention.
- Outer sleeve made by Iron steel so that sleeve can be weld with structure easily.



MRP:- 1570/-

GLASS SLIDING FOLDING DOOR SYSTEM



Features:

- Gaskets to Prevent Glass Damage
- Track 3600/4800mm
- Max Panel Weight 80 kg
- Max panel width 800 mm
- Max height 2400 mm
- Material SS304

HDSL-001-G

Glass to Glass Connector with stopper

Top Fitting

Application:- Sliding Folding Panels
Connector With Guide Locator



Specifications

- Secure grip with glasses
- Ensures friction free folding action of the doors
- Allen key screw for firm grip
- Finish SSS

MRP -₹ 12750/-

Bottom Fitting

Application:- Sliding Folding Panels
Connector With Lock

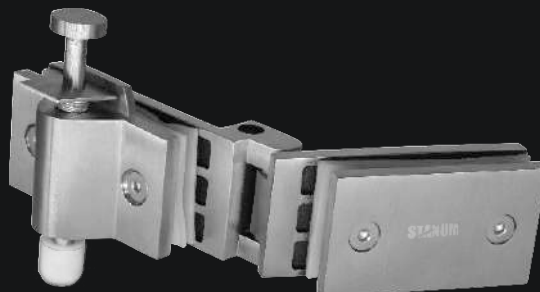

Specifications

- Connects panels at the bottom
- Locking pin provided for locking the panel with floor
- Spring loaded locking pin
- Locking pin can be released by pressing the release knob
- Allen key screw for firm grip
- Finish SSS

HDSL-002-G

Intermediate Roller with Guide



Top Fitting

Application:- Sliding Folding Panels
Connector With Roller Assembly

Specifications

- Secure grip on glasses
- With four friction free rollers
- Gaskets provided to prevent damage of glass and secure grip
- Allen Key Screw for firm grip
- Guide location for free sliding action.
- Finish SSS

MRP -₹ 12200/-

Bottom Fitting

Application:- Sliding Folding Panels
Connector With Guide Locator

Specifications

- Secure grip with glasses
- Ensures friction free folding action of the doors
- With four friction free rollers
- Gaskets provided to prevent damage of glass and for firm grip.
- Allen Key Screw for firm grip
- Finish SSS

HDSL-003-G

End Roller with Guide Roller

Top Fitting

Application:- Sliding Folding Panel Top End Fitting

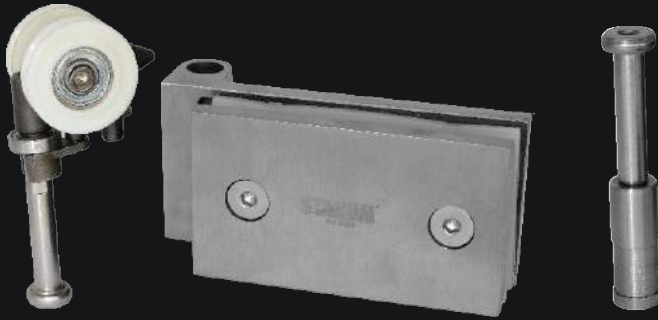

Bottom Fitting

Application:- Sliding Folding Swing Panel Bottom Fitting

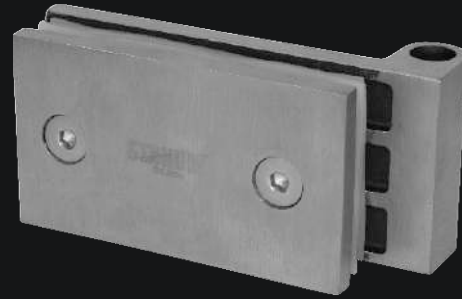

Specifications

- Secure grip on glasses
- Two friction free rollers
- Rollers with independent bearing for free rolling action
- Ensures soundless operation
- Gaskets provided to prevent damage of glass and secure grip
- Allen key screw for firm grip
- Finish SSS

Specifications

- With pivot pin secured with plastic bushing
- Designed for perfect seating with bottom track
- Stainless Steel Grade 304 Cover Plate
- Cover plate secured with 'L' key
- Off set pivot point to keep pivot line perfectly vertical
- Finish SSS

MRP -₹ 8000/-

HDSL-004-G

Wall to Glass Connecting Hinge

Top / Bottom Fitting

Application:- Wall To Glass Hinge

Specifications

- Hinge suitable for swing door system
- Designed to follow sliding folding system components concept
- Finish SSS

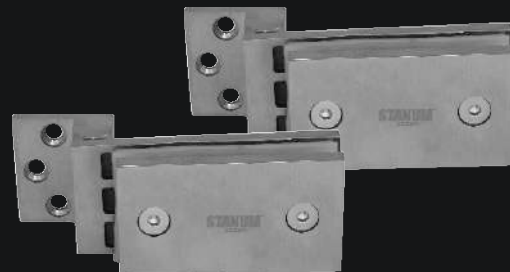

MRP -₹ 7400/-

HDSL-005

Sliding Folding Swing Panel Top Fitting
With pivot block

Specifications

- Designed for perfect seating with top track
- Smooth pivot point for friction less swing action
- With Stainless Steel Casting Grade 304
- Cover plate secured with 'L' key
- Better gripping nylon gasket
- Offset pivot point to keep glass panel in line
- Finish SSS
- Sliding Folding Swing Panel Bottom Fitting
With pivot pin secured with sss
- Designed for perfect seating with bottom track
- Offset pivot point to keep pivot line perfectly vertical
- Finish SSS

MRP:- 7500/-

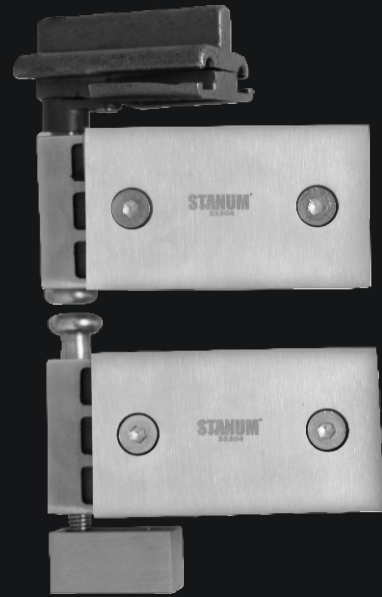

HDSL-006-G

Central Fitting with Handle

Specifications

- Connects panels at the Center with handle.
- Secure grip on glasses
- Gaskets provided to prevent damage
of glass and secure grip
- Recessed handle
- Finish SSS

MRP -₹ 5800/-

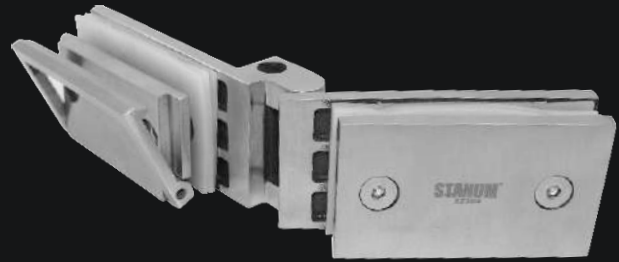

HDSL-007

Sliding Folding Panel Bottom End Fitting for odd panels
Locking pin provided for locking the panel with floor

Specifications

- Spring loaded locking pin
- Better gripping nylon gasket
- Locking pin can be released by pressing the release knob
- Finish SSS
- Left right as per site requirement

MRP -₹ 7200/-



HDSL-008-G to G

Glass to Glass sliding door lock

Specifications

- Suitable for glass thickness 10-12 mm
- Supplied with euro profile cylinder and high security keys
- Stainless Steel Grade 304
- With strike Box
- One Side key one side knob.

MRP -₹ 12500/-

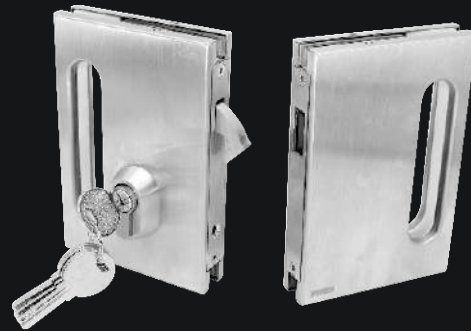

HDSL-009-G to W

Glass to Wall sliding door lock

Specifications

- Suitable for glass thickness 10-12 mm
- Supplied with euro profile cylinder and high security keys
- Stainless Steel Grade 304
- with strike Plate
- One Side key one side knob.

MRP -₹ 9500/-



HDSL-TT Top Track

(Available -3600mm / 4800 mm)

Features:

- Mounted to the ceiling
- Total height 50mm
- Total width 50mm
- Perfect curvature to accommodate rollers

Aluminum alloy track

Sturdy and rigid design for smooth working of the system

Available in 3600mm. & 4800mm. length

12 ft. MRP: - 10000/

16 ft. MRP: - 12000/



HDSL-BT Bottom Track

(Available -3600mm / 4800 mm)

12 ft. MRP: - 7000/

16 ft. MRP: - 9000/

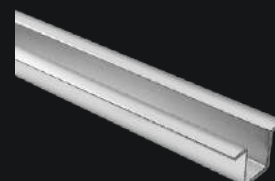

HCSF-001

Features:

- Hinge wall to glass mounted
- Hinges keeps the panels flat when closed
- Panels are connected with hinge
- Cover plate of hardware secured with grub screw
- Material SS 304 grade
- Finish satin stainless steel
- Batter griping with gasket
- Glass thiknes-8-12mm

MRP:- 5850/-

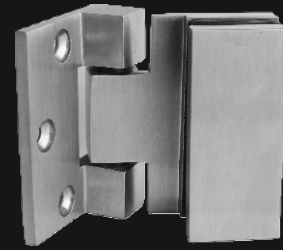

HCSF-002

Features:

- Hinges keeps the panels flat when closed
- Panels are connected with hinge
- Cover plate of hardware secured with grub screw
- Material SS 304 grade
- Finish satin stainless steel
- Batter griping with gasket
- Glass thiknes-8-12mm

MRP:- 5050/-

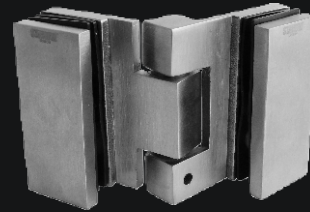

HCSF-003

Features:

- Top track required
- Hinges keeps the panels flat when closed
- Nylon wheels with integrated bearings for quite & smooth running
- Panel height adjustable with roller
- Panels are connected with hinge
- Cover plate of hardware secured with grub screw
- Material SS 304 grade
- Finish satin stainless steel
- Batter griping with gasket
- Glass thiknes-8-12mm
- Door Height 2400mm

MRP:- 5050/-



HCSF-004

Features:

- Digging required
- Locking panels
- Material SS 304 grade
- Finish satin stainless steel
- Batter griping with gasket
- Glass thiknes-8-12mm

MRP:- 6274/-

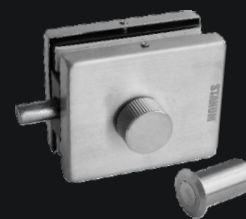

HDSL-TT

Top Track

(Available -3600mm / 4800 mm)

Features:

Top track for Central sliding folding system

- Mounted to the ceiling
 - Total height 50mm
 - Total width 50mm
 - Perfect curvature to accommodate rollers
- Aluminum alloy track
Sturdy and rigid design for smooth working of the system

12 ft. MRP: - 10000/

16 ft. MRP: - 12000/



SPIGOT & RAILING FITTINGS



Features:

- SS304
- Glass thickness 10-12 mm
- Gaskets to prevent glass damage and to provide firm grip.



HRA-02

BALUSTER RAILING (To Fix Glass with Stud)

Features

1. Pre-fabricated post with base plate and glass connectors
2. Simple On-Site Installation
3. Multiple Post Sizes for Relevant Load Requirements

MRP:- 2150/-



HRA-03

BALUSTER RAILING (To Fix Glass with Stud)

Features

1. Pre-fabricated post with base plate and glass connectors
2. Simple On-Site Installation
3. Multiple Post Sizes for Relevant Load Requirements

MRP:- 2300/-



HRA-04

BALUSTER RAILING (To Hold Glass with Stud)

Features

1. Pre-fabricated post with base plate and glass connectors
2. Simple On-Site Installation
3. Multiple Post Sizes for Relevant Load Requirements

MRP:- 2800/-



HRA-05

BALUSTER RAILING - 5.3inch (To Hold Glass with Spigot)

Features

1. Pre-fabricated post with base plate
2. Simple on-site installation, cutout not required
3. Multiple post sizes for relevant load requirements

MRP:- 2050/-



HRA-06

BALUSTER RAILING (To Hold Glass with Spigot)

(Available in :- 6 inch & 9 inch)

Features

1. Pre-fabricated post with base plate
2. Simple On-Site Installation
3. Multiple Post Sizes for Relevant Load Requirements

6 inch:- MRP:- 2500/-

9 inch:- MRP:- 3600/-



Canopy

HCF-01-SSS

Wall to Glass Holder Connector 90°

Features

1. More threads to adjust as per height of canopy
2. Useful for smaller size canopy fitting
3. To hold Glass with wall at 90°

MRP:- 6000/-



HCF-02-SSS

Glass Connector for Canopy Fitting to hold Glass for Canopy Width

Features

- To be used along with HCF-03-SSS with cable or rod
- Length can be adjusted as per requirement
- To be used in pairs

MRP:- 8000/-



HCF-03-SSS

Wall to Rod Connector for canopy Fitting to Hold rod to the wall

Features

- To be used with HCF-02-SSS with cable or rod
- Firm base for safe canopy fitting
- to be used in pairs

MRP:- 7000/-



HCF-01-S

Wall to Glass Holder Connector

Features

- Adjustable Angle as per the Requirement.
- Firm base for safe canopy fitting.
- To be used in pairs
- To hold glass with wall Adjustable

MRP:- 2300/-



HCF-02-S

To Hold Glass with Cable or rod

Features

- Adjustable Angle as per the Requirement.
- To be used along with HCF-03-S with cable or rod
- Wall connector for canopy
- To be used in pairs

MRP:- 2000/-



HCF-03-S

To Hold Cable or rod with wall

Features

- Adjustable Angle as per the Requirement.
- To be used along with HCF-02-S
- To be used in pairs

MRP:- 1600/-



HCF-ROD-10mm
Connecting Rod

MRP:- 2000/-



HCF-ROD-16mm
Connecting Rod

MRP:- 2250/-



HGL-PR-01-AN

Glazing Profile

MRP:- 3600/-



Features

- Attached with ceiling, floor or wall
- Available in lengths of 10 ft
- Easy and simple installation of the glass panel.
- Low maintenance cost
- Slim & attractive design. Low visual impact saving
- Used For 10 or 12 MM glass thickness
- Finish: Anodised

Glazing Profile end caps

MRP:- 160/-

AUTOMATIC DOORS



Features

- Compact and Sleek Design , Low Noise, Low Power
- 108 MM Channel Height.
- Error Display.
- Antistatic Brushes.
- Hybrid Safety Sensor*.
- **Application:** Airports, Hospitals, Shopping Complexes, Showrooms, Warehouses, Commercial Complexes, General Stores, Museums etc.

Automatic Sliding Doors HAD-XEO-4200

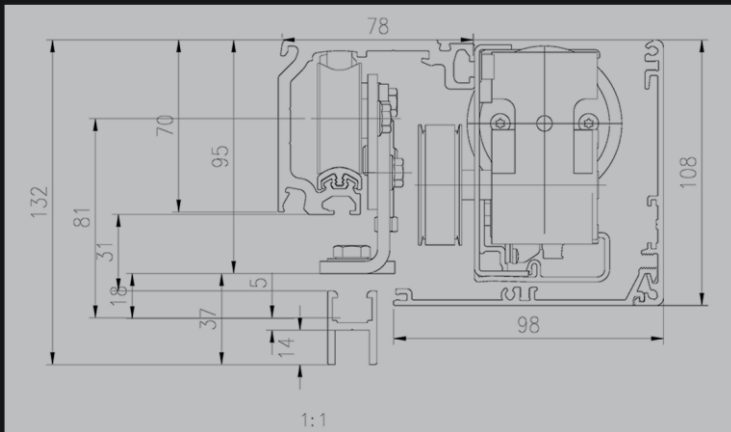
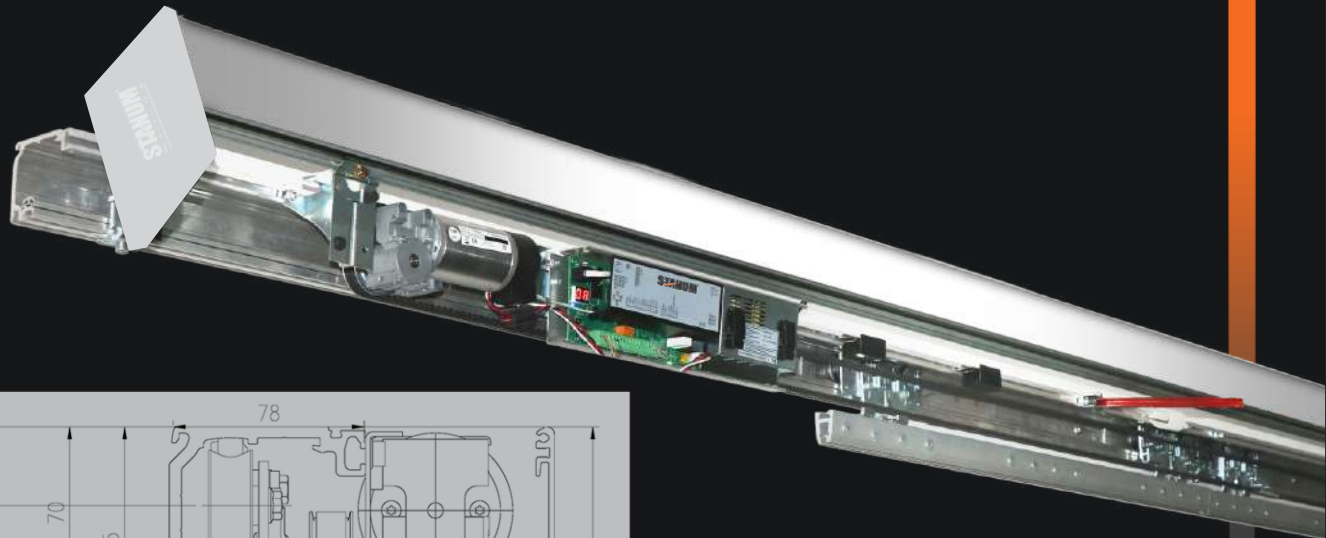

MRP:- 94500/-

Technical Parameters

Max. door Weight	1x120 Kg, 2x75 Kg
Door Height	UP to 2500 MM Max.
Clear Width	800 – 2000 MM
Installation	Surface, Ceiling, Lintel
Static Power Consumption	25W
Opening Speed	100-500 mm/sec.
Closing Speed	100-400 mm/ sec.
Hold Time	20 sec (Adjustable)
Features	Automatic Reverse, Partial opening , Automatic Lockin, Locked Mode
Emergency Open (Manually)	Yes
Supply Voltage	230VAC , 50/60 HZ
Sensors	Hybrid (Actuation + Safety)
Certifications	CE,ISO-9001

Automatic Sliding Doors

HAD-XEO-6200

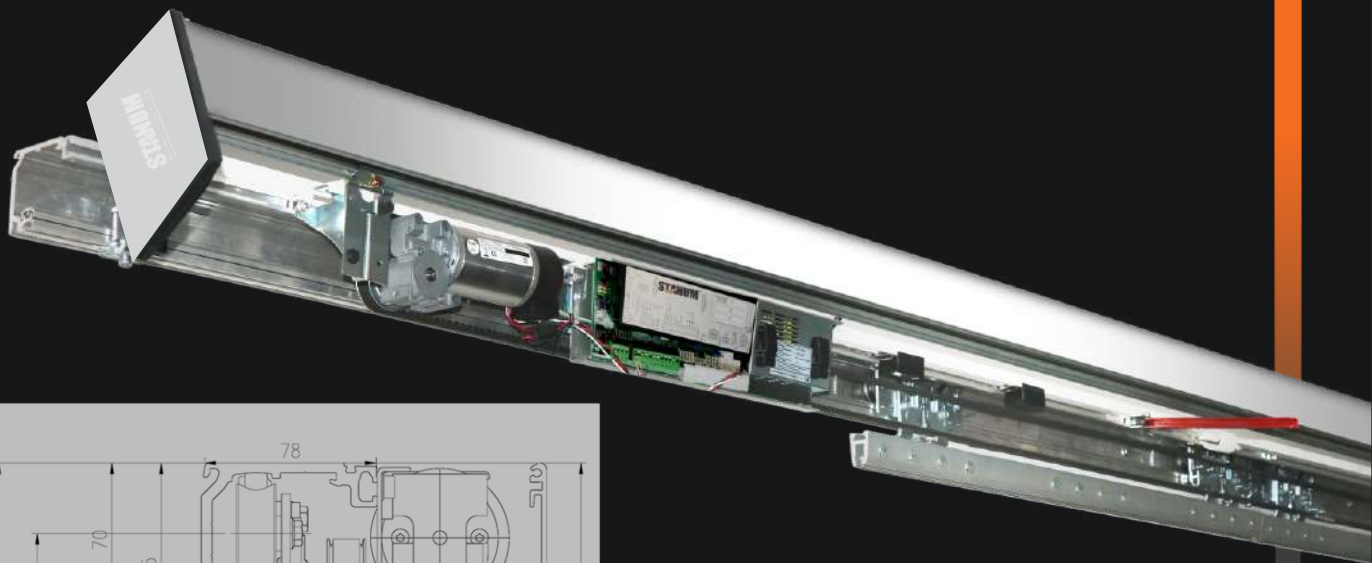

MRP:- 155000/-

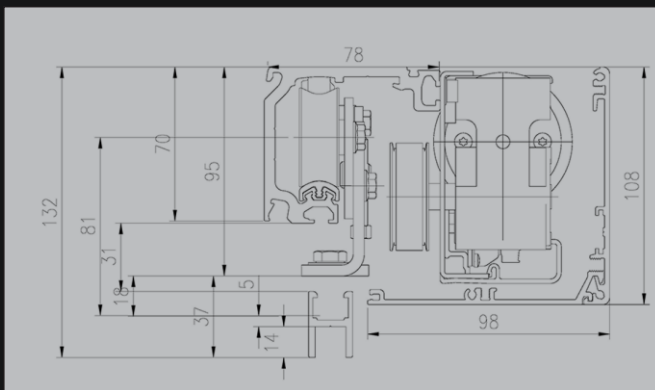

Technical Parameters



Max. door Weight	1 X 120 Kg, 2 X 90 Kg
Door Height	Up To 2500 MM
Clear Width	800-3000 MM
Installation	Surface Lintel, Ceiling.
Static Power Consumption	25W
Opening Speed	100-700 mm/sec.
Closing Speed	100-500 mm/sec.
Hold Time	20 sec (Adjustable)
Features	Automatic Reverse, Partial Opening, Automatic Locking, Locked Mode, Holding Bar
Emergency Open (Manually)	Yes
Supply Voltage	230VAC , 50/60 HZ
Sensors	Hybrid (safety + Activation)
Standard Compliance	EN16005, DIN 18650, EN ISO 13 849.
Temperature Range (°c)	-15°c To 50°c
Easy Programmer For Programming And Settings.	

Automatic Overhead Swing Door Operator. HAD-SD-80



Technical Specification

Max. Door width	≤ 900mm
Max. Door weight	≤ 60KG
Open angle	90°- 130°adjustable
Open direction	One Side
Hold open time	1-30 seconds adjustable
Opening speed	4-10 seconds adjustable
Closing speed	4-10 seconds adjustable
Remote control function	Open, close, lock ,hold open function
Installation	For framed door
Push Open	Yes
Manual Opening	Yes (in case of power failure)
Automatic Reverse on obstacle	Yes
Close buffer function	Yes
Power supply	220V
Power	Static 6W, maximum 60W
Dimension of main machine	Length 351*Width 82*Height 75
Two-door interlock function	Available
Integration	Possible with sensors, ACS, biometric devices etc.

MRP:- 50000/-

Automatic Concealed Swing Door Operator HAD-CSD-150



Technical Specification

Max. Door width	≤ 1200mm
Max. Door weight	≤ 150KG
Open angle	90°- 130°adjustable
Open direction	Optional
Hold open time	1-30 seconds adjustable
Opening speed	4-10 seconds adjustable
Closing speed	4-10 seconds adjustable
Installation	For framed doors
Push Open	Yes
Manual Opening	Yes (In case of power failure)
Remote control function function	Open, close, lock ,hold open
Automatic Reverse on obstacle	Yes
Close buffer function	Yes
Power supply	220V
Power	Static 5W, maximum 40W
Dimension of main machine	Length 354*Width 148*Height 68
Two-door interlock function	Available
Integration	Possible with sensors, ACS, biometric devices etc.

MRP:- 72000/-

AUTOMATIC DOOR ACCESSORIES

HAD-ACC-HS

STANUM HYBRID automatic sliding door motion & safety sensor

(Microwave radar activation & active infrared safety dual mode combination sensor)

STANUM HYBRID motion detector triggers the door's opening and also function as a safety sensor to improve the pedestrian experience of using automatic doors and avoid unnecessary accidents.





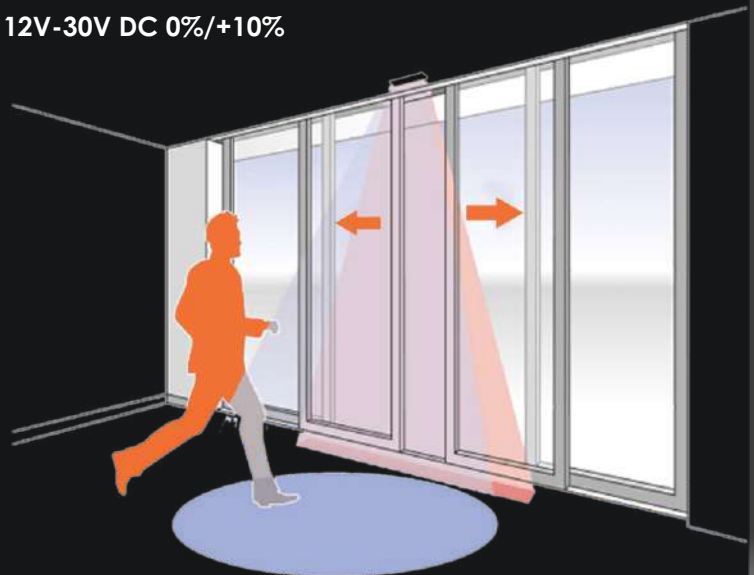

Technical Specifications

- Supply voltage: 12V-24V AC +/-10%, 12V-30V DC 0%/+10%
- Power consumption: <3W
- Mounting height: 1.8m – 3.0m
- Temperature range: -25°C – +55°C
- Degree of protection: IP54



MRP:- 13100/-

Supply voltage:	12 V - 24 V AC +/-10% ; 12 V - 30 V DC 0%/+10%	
Power consumption:	< 3 W	
Mounting height:	1.8 m to 3 m	
Temperature range:	-25 °C to +55 °C	
Degree of protection:	IP54	
	  GREEN LED	  RED LED
Detection mode:	Motion Min. detection speed: 5 cm/s	Presence Typical response time: <128 ms (max. 500 ms)
Technology:	Microwave doppler radar Transmitter frequency: 24.150 GHz Transmitter radiated power: < 20 dBm EIRP Transmitter power density: < 5 mW/cm ²	Active infrared with background analysis Spot diameter: 6 cm (typ) Number of spots: 24 by curtain Number of curtains: 1
Angle:	From 15 ° to 45 ° vertical (adjustable)	From -5 ° to +8 ° (adjustable)
Output:	Relay (free of potential) Max. contact voltage: 42 V AC/DC Max. contact current: 1 A (resistive) Max. switching power: 30 W (DC)/60 VA (AC)	Relay (free of potential) Max. contact voltage: 42 V AC/DC Max. contact current: 1 A (resistive) Max. switching power: 30 W (DC)/60 VA (AC)
Hold time output signal:	0.5 s	0.5 s

AUTOMATIC DOOR ACCESSORIES

HAD-ACC-WPP

Wireless Push Plate

FEATURES

- 434 MHz wireless is the ideal solution for specific applications where sensors are not suitable.
- 2 wireless push plate + 1 receiver.
- Can be installed on the door or on a wall.
- Life time of battery minimum 1 year. (2 x AAA)
- LED visual signal.
- Range upto 25m in LOS.
- Plug and play.

MRP:- 14100/-



HAD-ACC-PBM

Wired Push Button Metallic

- Different shapes and dimensions (round, square, Jamb).
- Stainless steel material.
- Resist scratches.
- For low energy doors.

MRP:- 10500/-



HAD-ACC-MS

Magic Switch

- **Technology** Microwave motion sensor
- **Radiated frequency** 24.150 Ghz
- **Supply voltage** 12 - 30V DC +/- 10%
- Antimicrobial front face
- **Power consumption** < 1.5W
- **Sensing distance** Adjustable 10-60cm

MRP:- 11250/-



HAD-ACC-MS01

Wireless Magic Switch

- **Technology** Infrared
- **Radiated frequency** RF315MHZ
- **Sensing distance** Adjustable 1-15cm
- **Supply voltage** 12 – 36 VDC

MRP:- 8100/-



AUTOMATIC DOOR ACCESSORIES

HAD-ACC-GC

Glass Clamp

- For frameless Glass
- Available in 1 mtr. & 1.5 mtr length
- Glass held by gaskets for better hold
- No need for cutouts

1 Mtr. - MRP:- 7800/-

1.5 Mtr. - MRP:- 11500/-

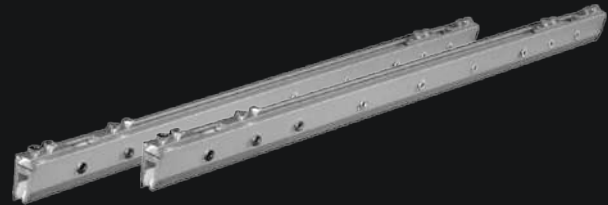

HAD-ACC-FG

Floor Guide for frameless Glass Door

- For frameless glass doors.
- Suitable for 10mm & 12mm glass thickness
- With Brushes for noiseless and scratch free action
- Easy Installation

MRP:- 1050/-



HAD-ACC-FG-F

Floor Guide for framed/wooden Door

- For framed/wooden door
- Adjustable width 35mm-50mm
- With Brush and roller guider for noiseless and scratch free action

MRP:- 1550/-



HAD-ACC-KS4

4 Way Key Switch

- Continuous opening Mode
- Automatic Mode
- Partial Opening Mode
- Locked Mode

MRP:- 7650/-



HAD-ACC-MWS

Microwave Sensor

- Supply voltage: 12V-24V AC +/-10%, 12V-30V DC 0%/+10%
- Power consumption: <3W
- Mounting height: 1.8m – 3.0m
- Temperature range: -25°C – +55°C
- Degree of protection: IP54

MRP:- 7200/-



AUTOMATIC DOOR ACCESSORIES

HAD-ACC-PBP

Plastic Push Button

- With 'Door Exit' written on button
- High grade plastic

MRP:- 225/-



HAD-ACC-SFS

Safety Sensor

- Infrared.
- Easy installation.
- Higher user safety

MRP:- 22750/-



HAD-FS-01

Foot Sensor

- Photoelectric type
- Toe insert type
- Embedded in wall
- 12VDC

MRP:- 9150/-



HAD-ACC-MWS-02

Microwave Sensor

- Microwave (unidirectional)
- Supply voltage: 12V-24V AC +/-10%, 12V-30V DC 0%/+10%
- Power consumption: <3W
- Mounting height: 1.8m – 3.0m
- Temperature range: -25°C – +55°C

MRP:- 6250/-



FGDS-103

Full Set With Handle (Corner Lock)

MRP: ₹ 13720/



HFS-103



HPF-2102-SN



HPF-2103-SN



HPF-2112-SN



HPL-2113-SN



HPH-5101-MB

Full Set With Handle (G to G) (Centre Lock)

MRP: ₹ 13820/



HFS-103



HPF-2102-SN



HPF-2103-SN



HPF-2112-SN



HGDL-104



HPH-5101-MB

Full Set Without Handle

MRP: ₹ 12220/



HFS-103



HPF-2102-SN



HPF-2103-SN



HPF-2112-SN



HPL-2113-SN

Full Set with Handle without Lock

MRP: ₹ 11720/



HFS-103



HPF-2102-SN



HPF-2103-SN



HPF-2112-SN



HPH-5101-MB

Half Set without Handle & Lock

MRP: ₹ 10220/



HFS-103



HPF-2102-SN



HPF-2103-SN



HPF-2112-SN

Wooden Door Set with Accessories

MRP: ₹ 7750/



HFS-103



FSA-01

FGDS-124

Full Set With Handle (Corner Lock)

MRP: ₹13920/-



HFS-124



HPF-2102-SN



HPF-2103-SN



HPF-2112-SN



HPL-2113-SN



HPH-5101-MB

Full Set With Handle (G to G) (Centre Lock)

MRP: ₹14020/-



HFS-124



HPF-2102-SN



HPF-2103-SN



HPF-2112-SN



HGDL-104



HPH-5101-MB

Full Set Without Handle

MRP: ₹ 12420/-



HFS-124



HPF-2102-SN



HPF-2103-SN



HPF-2112-SN



HPL-2113-SN

Full Set with Handle without Lock

MRP: ₹ 11920/-



HFS-124



HPF-2102-SN



HPF-2103-SN



HPF-2112-SN



HPH-5101-MB

Half Set without Handle & Lock

MRP: ₹ 10420/-



HFS-124



HPF-2102-SN



HPF-2103-SN



HPF-2112-SN

Wooden Door Set with Accessories

MRP: ₹ 7950/-



HFS-124



FSA-01

FGDS-154

Full Set With Handle (Corner Lock)

MRP: ₹ 14570/-



HFS-154



HPF-2102-SN



HPF-2103-SN



HPF-2112-SN



HPL-2113-SN



HPH-5101-MB

Full Set With Handle (G to G) (Centre Lock)

MRP: ₹ 14670/-



HFS-154



HPF-2102-SN



HPF-2103-SN



HPF-2112-SN



HGDL-104



HPH-5101-MB

Full Set Without Handle

MRP: ₹ 13070/-



HFS-154



HPF-2102-SN



HPF-2103-SN



HPF-2112-SN



HPL-2113-SN

Full Set with Handle without Lock

MRP: ₹ 12570/-



HFS-154



HPF-2102-SN



HPF-2103-SN



HPF-2112-SN



HPH-5101-MB

Half Set without Handle & Lock

MRP: ₹ 11070/-



HFS-154



HPF-2102-SN



HPF-2103-SN



HPF-2112-SN

Wooden Door Set with Accessories

MRP: ₹ 8600/-



HFS-154



FSA-01

FGDS-204

Full Set With Handle (Corner Lock)

MRP: ₹ 21870/-



HFS-204



HPF-2102-SN



HPF-2103-SN



HPF-2112-SN



HPL-2113-SN



HPH-5101-MB

Full Set With Handle (G to G) (Centre Lock)

MRP: ₹ 21970/-



HFS-204



HPF-2102-SN



HPF-2103-SN



HPF-2112-SN



HGDL-104



HPH-5101-MB

Full Set Without Handle

MRP: ₹ 20370/-



HFS-204



HPF-2102-SN



HPF-2103-SN



HPF-2112-SN



HPL-2113-SN

Full Set with Handle without Lock

MRP: ₹ 19870/-



HFS-204



HPF-2102-SN



HPF-2103-SN



HPF-2112-SN



HPH-5101-MB

Half Set without Handle & Lock

MRP: ₹ 18370/-



HFS-204



HPF-2102-SN



HPF-2103-SN



HPF-2112-SN

Wooden Door Set with Accessories

MRP: ₹ 15900/-



HFS-204



FSA-01

FGDS-502

Full Set With Handle (Corner Lock)

MRP: ₹ 9520/-



HFS-502



HPF-2102-SN



HPF-2103-SN



HPF-2112-SN



HPL-2113-SN



HPH-5101-MB

Full Set With Handle (G to G) (Centre Lock)

MRP: ₹ 9620/-



HFS-502



HPF-2102-SN



HPF-2103-SN



HPF-2112-SN



HGDL-104



HPH-5101-MB

Full Set Without Handle

MRP: ₹ 8020/-



HFS-502



HPF-2102-SN



HPF-2103-SN



HPF-2112-SN



HPL-2113-SN

Full Set with Handle without Lock

MRP: ₹ 7520/-



HFS-502



HPF-2102-SN



HPF-2103-SN



HPF-2112-SN



HPH-5101-MB

Half Set without Handle & Lock

MRP: ₹ 6020/-



HFS-502



HPF-2102-SN



HPF-2103-SN



HPF-2112-SN

Wooden Door Set with Accessories

MRP: ₹ 3550/-



HFS-502



FSA-01

FGDS-602

Full Set With Handle (Corner Lock)

MRP: ₹ 9820/-



HFS-602



HPF-2102-SN



HPF-2103-SN



HPF-2112-SN



HPL-2113-SN



HPH-5101-MB

Full Set With Handle (G to G) (Centre Lock)

MRP: ₹ 9920/-



HFS-602



HPF-2102-SN



HPF-2103-SN



HPF-2112-SN



HGDL-104



HPH-5101-MB

Full Set Without Handle

MRP: ₹ 8320/-



HFS-602



HPF-2102-SN



HPF-2103-SN



HPF-2112-SN



HPL-2113-SN

Full Set with Handle without Lock

MRP: ₹ 7820/-



HFS-602



HPF-2102-SN



HPF-2103-SN



HPF-2112-SN



HPH-5101-MB

Half Set without Handle & Lock

MRP: ₹ 6320/-



HFS-602



HPF-2102-SN



HPF-2103-SN



HPF-2112-SN

Wooden Door Set with Accessories

MRP: ₹ 3850/-



HFS-602



FSA-01

FGDS-702

Full Set With Handle (Corner Lock)

MRP: ₹ 10420/-



HFS-702



HPF-2102-SN



HPF-2103-SN



HPF-2112-SN



HPL-2113-SN



HPH-5101-MB

Full Set With Handle (G to G) (Centre Lock)

MRP: ₹ 10520/-



HFS-702



HPF-2102-SN



HPF-2103-SN



HPF-2112-SN



HGDL-104



HPH-5101-MB

Full Set Without Handle

MRP: ₹ 8920/-

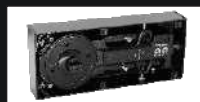

HFS-702



HPF-2102-SN



HPF-2103-SN



HPF-2112-SN



HPL-2113-SN

Full Set with Handle without Lock

MRP: ₹ 8420/-



HFS-702



HPF-2102-SN



HPF-2103-SN



HPF-2112-SN



HPH-5101-MB

Half Set without Handle & Lock

MRP: ₹ 6920/-



HFS-702



HPF-2102-SN



HPF-2103-SN



HPF-2112-SN

Wooden Door Set with Accessories

MRP: ₹ 4450/-



HFS-702



FSA-01

FGDS-802

Full Set With Handle (Corner Lock)

MRP: ₹ 10970/-



HFS-802



HPF-2102-SN



HPF-2103-SN



HPF-2112-SN



HPL-2113-SN



HPH-5101-MB

Full Set With Handle (G to G) (Centre Lock)

MRP: ₹ 11070/-



HFS-802



HPF-2102-SN



HPF-2103-SN



HPF-2112-SN



HGDL-104



HPH-5101-MB

Full Set Without Handle

MRP: ₹ 9470/-

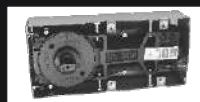

HFS-802



HPF-2102-SN



HPF-2103-SN



HPF-2112-SN



HPL-2113-SN

Full Set with Handle without Lock

MRP: ₹ 8970/-



HFS-802



HPF-2102-SN



HPF-2103-SN



HPF-2112-SN



HPH-5101-MB

Half Set without Handle & Lock

MRP: ₹ 7470/-



HFS-802



HPF-2102-SN



HPF-2103-SN



HPF-2112-SN

Wooden Door Set with Accessories

MRP: ₹ 5000/-



HFS-802



FSA-01

80Kg

Glass Door Sets

HHP-080

Hydraulic Patch Set With Handle 80Kg

MRP: ₹ 11880/-



HHP-080



HPF-2102-SN



HPF-2112-SN



HPH-5101-MB

Hydraulic Patch Set Without Handle

MRP: ₹ 10380/-



HHP-080



HPF-2102-SN



HPF-2112-SN

HHP-090

Hydraulic Patch Set With Handle

MRP: ₹ 12670/-



HHP-090



HPF-2102-SN



HPF-2112-SN



HPH-5101-MB

Hydraulic Patch Set Without Handle

MRP: ₹ 11170/-



HHP-090



HPF-2102-SN



HPF-2112-SN

100 Kg

APARTMENT LOCKS



HAL-007

Apartment Locks

- Unlock Methods : Fingerprint, IC Card, Password, app
- Material : Zinc Alloy
- Fingerprints : <= 100
- Card + Passwords : <= 100
- Administrators : 9
- Working Temperature : -10-60 °C
- Humidity : 20%–93%
- Battery : 4AAA
- Mechanical Key : Yes (Super C key) 2 PCS
- Door Thickness : 35-70 MM
- Privacy password : Yes
- Auto Freeze : Yes
- Low Battery Alarm : Yes

MRP:- 16300/-



HAL-008

Apartment Locks

- Unlock Methods : Fingerprint, IC Card, Password, app
- Material : Aluminium Alloy
- Fingerprints : <= 100
- Card + Passwords : <= 200
- Administrators : 9
- Working Temperature : -10-60 °C
- Humidity : 20%–93%
- Battery : Lithium Rechargeable battery
- Mechanical Key : Yes (Super C key) 2 PCS
- Door Thickness : 40-90 MM
- Privacy password : Yes
- Auto Freeze : Yes
- Low Battery Alarm : Yes

MRP:- 29300/-



HAL-009

Apartment Locks

- Unlock Methods : Fingerprint, IC Card, Password, app
- Material : Aluminium Alloy
- Fingerprints : <= 100
- Card + Passwords : <= 200
- Administrators : 9
- Working Temperature : -10-60 °C
- Humidity : 20%–93%
- Battery : Lithium Rechargeable battery
- Mechanical Key : Yes (Super C key) 2 PCS
- Door Thickness : 40-90 MM
- Privacy password : Yes
- Auto Freeze : Yes
- Low Battery Alarm : Yes

MRP:- 34200/-



HAL-013

Apartment Locks

•Facial Recognition Lock	:	Fingerprint, IC Card, Password, 3D face recognition
•Unlock Methods	:	
•Material	:	Zinc Alloy
•Fingerprints	:	<= 100
•Face	:	<= 50
•Card + Passwords	:	<= 250
•Administrators	:	09
•Working Temperature	:	-10-60 °C
•Humidity	:	20%--93%
•Battery	:	Lithium Rechargeable battery
•Mechanical Key	:	Yes (Super C key) 2 PCS
•Door Thickness	:	40-90 MM
•Privacy password	:	Yes
•Auto Freeze	:	Yes
•Low Battery Alarm	:	Yes



MRP:- 48100/-

HAL-014

Apartment Locks

Features:-

Administrators	09
Fingerprints	100
Passwords+ cards	200
APP	Yes
Mechanical Key	Yes (2)
Emergency Power Supply	Yes
Battery	4 AAA
Min. Door Thickness	35 MM

(Available in sliding & swing door)



MRP:- 26200/-

HAL-015

Apartment Locks

Features:-

Administrators	09
Fingerprints	100
Passwords+ cards	200
APP	Yes
Mechanical Key	Yes (2)
Emergency Power Supply	Yes
Battery	4 AAA
Min. Door Thickness	35 MM



MRP:- 26200/-

HAL-016

Apartment Locks

Fingerprints	<= 100
Passwords	<= 200
APP	Yes
Mechanical Keys	Yes (2)
USB Power Supply	Yes 9V
Battery	4 AAA
Min. Door Thickness	35-70 MM
Finishes	Gold and Black
Continuous opening mode	Yes
Batteries	4AAA



HAL-016-G

MRP:- 16300/-



HAL-016-BM

MRP:- 15500/-

HOTEL LOCKS

- SS304 + ABS
- Satin
- 4 AA Batteries
- Low Battery Indicator
- 890 Trail Records
- Door Thickness : 35-70MM
- Mechanical Key Override
- Windows XP/W7/W8/W10
- Auto Backup function
- Working Temperature -15°- 60°C
- Battery Life 14 Months
- Bluetooth /App Function (Optional)
- PMS Integration Possible



HHL-003-S
Hotel Locks

- SS304 + ABS
- Satin
- 4 AA Batteries
- Low Battery Indicator
- 890 Trail Records
- Door Thickness : 35-55MM
- Mechanical Key Override
- Windows XP/W7/W8/W10
- Auto Backup function
- Working Temp. -15°- 60°C Temperature
- Battery Life 14 Months
- Bluetooth /App Function (Optional)
- PMS Integration Possible



MRP:- 6470/-

HHL-004-G
Hotel Locks

- Ss304 + ABS
- Satin
- 4 AA Batteries
- Low Battery Indicator
- 890 Trail Records
- Door Thickness : 35-55MM
- Mechanical Key Override
- Windows XP/W7/W8/W10
- Auto Backup function
- Working Temp. -15°- 60°C Temperature
- Battery Life 14 Months
- Bluetooth /App Function (Optional)
- PMS Integration Possible



MRP:- 7470/-

HHL-005
Hotel Locks

- Ss304 + ABS
- Satin
- 4 AA Batteries
- Low Battery Indicator
- 890 Trail Records
- Door Thickness : 35-55MM
- Mechanical Key Override
- Windows XP/W7/W8/W10
- Auto Backup function
- Working Temp. -15°- 60°C Temperature
- Battery Life 14 Months
- Bluetooth /App Function (Optional)
- PMS Integration Possible



MRP:- 11000/-

HHL-006
Hotel Locks

- Ss304 + ABS
- Satin
- 4 AA Batteries
- Low Battery Indicator
- 890 Trail Records
- Door Thickness : 35-55MM
- Mechanical Key Override
- Windows XP/W7/W8/W10
- Auto Backup function
- Working Temp. -15°- 60°C Temperature
- Battery Life 14 Months
- Bluetooth /App Function (Optional)
- PMS Integration Possible



MRP:- 14000/-



HHL-ACC-01
Encoder

MRP:- 18285/-



HHL-ACC-02
Data Card

MRP:- 845/-



HHL-ACC-03
MF - Card

MRP:- 105/-



HHL-ACC-04
Energy Saver

MRP:-1830/-



HHL-ACC-05
Lift Elevator System

On Request

Cabinet Lock

HCL-05

Cabinet Lock

- Material: Zinc Alloy
- Colour:Black
- User Capacity : 20 RFID Tags
- Front Panel Dimensions. : 92*50 mm
- Working Temp. : -30°C-60°C
- Low battery alarm : \leq 4.8 V
- 4AAA batteries
- Emergency power supply
- Door/panel thickness : 16-22 mm



MRP:- 3150/-

HCL-010

Cabinet Lock

- Material: ABS
- Colour:Black
- User Capacity : 2 passwords
- Front Panel Dia. : 50 MM
- Working Temp. : -30°-60°
- Low battery alarm : \leq 4.8 V
- 4AAA batteries
- Emergency power supply
- Door/panel thickness : 16-22 mm



MRP:- 2650/-

HCL-ACC-06

RFID Tag



MRP:- 280/-

HCL-011

Cabinet Lock

- Material: Zinc Alloy
- Colour:Black
- User Capacity : 100 fingerprints, 2 passwords
- Front Panel Dimensions. : 114*64 mm
- Working Temp. : -30°-60°
- Low battery alarm : \leq 4.8 V
- 3AAA batteries
- Emergency power supply
- Door/panel thickness : 16-22 mm



MRP:- 5800/-

HCL-012

Cabinet Lock

- Material: ABS
- Colour:Golden
- User Capacity : 20 RFID Tags
- Front Panel Dimensions. : 92*50 mm
- Working Temp. : -30°-60°
- Low battery alarm : \leq 4.8 V
- 4AAA batteries
- Emergency power supply
- Door/panel thickness : 16-22 mm



MRP:- 1950/-

DOOR CLOSER



Features:

- Mounting on wooden and framed doors
- Right and left hand opening door
- Thermostable fluid
- Adjustable arm
- Can withstand extreme temperature up to 70°C

HDC-401S

- Door weight up to 40 kg
- Door Closing Force EN-2
- Speed can be adjusted as per requirement
- Can withstand extreme temperature up to 70°C
- Right hand and left hand opening doors
- Mounting on wooden and aluminium doors
- Adjustable Arm
- Door width - 500-800

MRP:- 1075/-



Features:

- Three Lakh cycles tested
- Aluminium Pressure die casting body
- Two valve mechanism
- High grade oil used

HDC-601S

- Door weight up to 60 kg
- Door Closing Force EN-3
- Mounting on wooden and aluminium doors
- Speed can be adjusted as per requirement
- Can withstand extreme temperature up to 70°C
- Right hand and left hand opening doors
- Adjustable Arm
- Door width - 600-1200



Grey

Gold

Brown

MRP:- 1310/-



Features:

- Three Lakh cycles tested
- Aluminium Pressure die casting body
- Two valve mechanism
- High grade oil used

HDC-801S

- Door weight up to 80 kg
- Door Closing Force EN-4
- Speed can be adjusted as per requirement
- Can withstand extreme temperature up to 70°C
- Right hand and left hand opening doors
- Mounting on wooden and aluminium doors
- Adjustable Arm
- Door width - 900-1300

MRP:- 2260/-



Features:

- Three Lakh cycles tested
- Aluminum Pressure die casting body
- Two valve mechanism
- High grade oil used

HDC-652C

- Door weight up to 65 kg
- Door Closing Force EN-3
- Door opening angle of 120°
- Hold open mechanism
- Mounting on wooden and metallic doors
- Speed can be adjusted as per requirement
- Can withstand extreme temperature up to 70°C
- Right hand and left hand opening doors
- Hydraulic fluid for consistent closing speeds at extreme temperature fluctuations
- Door width - 600-1200

Features:

- Three Lakh cycles tested
- Aluminium extrusion / PDC body
- Two valve mechanism
- High grade oil used

MRP:- 3810/-

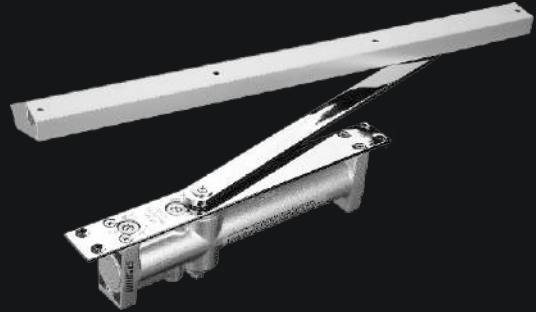

HDC-803T

- Door weight up to 80 kg
- Door Closing Force EN-4
- SS304 Cover Plate
- Door opening angle of 120°
- Hold Opening Mechanism
- Mounting on wooden and metallic doors
- Speed can be adjusted as per requirement
- Can withstand extreme temperature up to 70°C
- Right hand and left hand opening doors
- Hydraulic fluid for consistent closing speeds at extreme temperature fluctuations
- Door width - 900-1300

Features:

- Three Lakh cycles tested
- Aluminium extrusion / PDC body
- Two valve mechanism
- High grade oil used

MRP:- 3330/-



HDC-803T-BM

MRP:- 3580/-

HDC-105-F

- Door Weight upto 100 Kg.
- Right hand and left hand opening doors.
- Power Adjustable EN2 to EN5.
- Adjustable Arm
- Door width - 850-1250

Features

- Five Lakh cycles tested.
- High quality imported gaskets to prevent oil leakage.
- Strong Spring to guarantee powerful closing.
- Fine quality aluminium alloy body.
- Hydraulic control of closing speed by the help of adjustable valves



EN1634 TESTED

MRP:- 6600/-

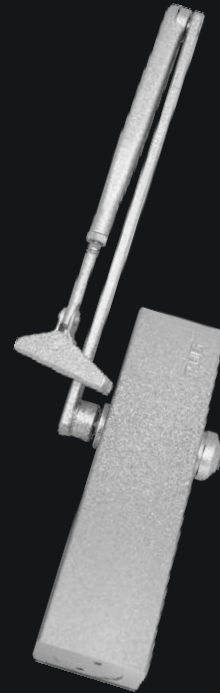

HDC-804-F

- Door Weight upto 80 Kg.
- Right hand and left hand opening doors.
- Power Adjustable EN2 to EN4
- Adjustable Arm
- Door width - 850-1100

Features

- Five Lakh cycles tested.
- High quality imported gaskets to prevent oil leakage.
- Strong Spring to guarantee powerful closing.
- Fine quality aluminium alloy body.
- Hydraulic control of closing speed by the help of adjustable valves.



EN1634 TESTED

MRP:- 3100/-



BALL BEARING DRAWER SLIDES



Features

- Standard ball bearing
- Soft close ball bearing
- Push open ball bearing
- Two ball bearing Mechanisum
- 35/45 Kgs
- Finish - Black & Zinc

STANDARD BALL BEARING SLIDES

- Weight Carrying Capacity : 45Kg
- Finish : Black & Zinc

HBB4510	10" Standard Ball Bearing Slide
HBB4512	12" Standard Ball Bearing Slide
HBB4514	14" Standard Ball Bearing Slide
HBB4516	16" Standard Ball Bearing Slide
HBB4518	18" Standard Ball Bearing Slide
HBB4520	20" Standard Ball Bearing Slide
HBB4522	22" Standard Ball Bearing Slide
HBB4524	24" Standard Ball Bearing Slide

MRP:- 325/-

MRP:- 400/-

MRP:- 465/-

MRP:- 535/-

MRP:- 605/-

MRP:- 670/-

MRP:- 745/-

MRP:- 810/-



STANDARD BALL BEARING SLIDES

- Weight Carrying Capacity : 35Kg
- Finish : Black & Zinc

HBB3510	10" Standard Ball Bearing Slide
HBB3512	12" Standard Ball Bearing Slide
HBB3514	14" Standard Ball Bearing Slide
HBB3516	16" Standard Ball Bearing Slide
HBB3518	18" Standard Ball Bearing Slide
HBB3520	20" Standard Ball Bearing Slide
HBB3522	22" Standard Ball Bearing Slide
HBB3524	24" Standard Ball Bearing Slide

MRP:- 285/-

MRP:- 330/-

MRP:- 380/-

MRP:- 435/-

MRP:- 485/-

MRP:- 535/-

MRP:- 585/-

MRP:- 635/-



SOFT CLOSE BALL BEARING SLIDES

- Weight Carrying Capacity : 35Kg
- Finish : Black & Zinc

HSC3510	10" Soft Close Ball Bearing Slide
HSC3512	12" Soft Close Ball Bearing Slide
HSC3514	14" Soft Close Ball Bearing Slide
HSC3516	16" Soft Close Ball Bearing Slide
HSC3518	18" Soft Close Ball Bearing Slide
HSC3520	20" Soft Close Ball Bearing Slide
HSC3522	22" Soft Close Ball Bearing Slide
HSC3524	24" Soft Close Ball Bearing Slide

MRP:- 505/-
MRP:- 575/-
MRP:- 635/-
MRP:- 700/-
MRP:- 760/-
MRP:- 825/-
MRP:- 950/-
MRP:- 1080/-



PUSH OPEN BALL BEARING SLIDES

- Push Open
- Weight Carrying Capacity : 35Kg
- Finish : Black & Zinc

HPO3510	10" Push Open Ball Bearing Slide
HPO3512	12" Push Open Ball Bearing Slide
HPO3514	14" Push Open Ball Bearing Slide
HPO3516	16" Push Open Ball Bearing Slide
HPO3518	18" Push Open Ball Bearing Slide
HPO3520	20" Push Open Ball Bearing Slide
HPO3522	22" Push Open Ball Bearing Slide
HPO3524	24" Push Open Ball Bearing Slide

MRP:- 535/-
MRP:- 595/-
MRP:- 660/-
MRP:- 720/-
MRP:- 785/-
MRP:- 850/-
MRP:- 975/-
MRP:- 1100/-



AUTO CLOSE CONCEALED HINGES



Auto Close Concealed Hinge

- Clip on
- Open Angle : 105°
- Door Thickness : 14-22 mm



HNH-450-2S
MRP:- 180/-

HNH-458-2S
MRP:- 185/-

HNH-4515-2S
MRP:- 185/-

Auto Close Concealed Hinge

- Slide on
- Open Angle : 105°
- Door Thickness : 14-22 mm



HNH-450-4S
MRP:- 125/-

HNH-458-4S
MRP:- 130/-

HNH-4515-4S
MRP:- 130/-

Auto Soft Close Concealed Hinge

- Soft Close
- Clip on
- Open Angle : 105°
- Door Thickness : 14-22 mm



HASC-450-2S
MRP:- 350/-

HASC-458-2S
MRP:- 355/-

HASC-4515-2S
MRP:- 355/-

Auto Soft Close Concealed Hinge

- Soft Close
- Clip on
- Open Angle : 105°
- Door Thickness : 14-22 mm

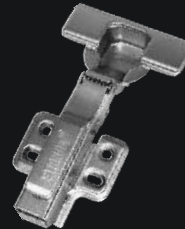

HASC-450-4S
MRP:- 380/-

HASC-458-4S
MRP:- 385/-

HASC-4515-4S
MRP:- 385/-

Auto Soft Close Concealed Hinge 3D

- 3D Adjustable
- Soft Close
- Clip on
- Open Angle : 105°
- Door Thickness : 14-22 mm

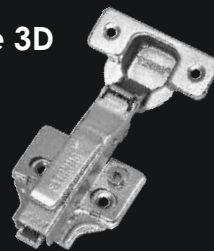

HASC-450-3D
MRP:- 405/-

HASC-458-3D
MRP:- 415/-

HASC-4515-3D
MRP:- 415/-



Features:-

- For Framed & Wooden Doors
- Finish - SSS
- Material - SS304

HMS-7171-CY/SS

Features:

Plate Handle Set

- Size - 202mm
- CTC - 57mm
- Material - Zinc
- Finish - CP/MATT
- Lock body 50*45mm - 2mm thick
- Back Set - 50mm
- CTC - 45mm
- Material - SS304
- Finish - Matt
- Key - 3nos
- Door Thickness - 40mm
- 6 lever pin
- K2K Cylinder - 60mm
- Euro Profile cylinder
- Application Wooden & Framed Door



MRP:- 2750/-

HMS-7172-KY/AN

Features:

Plate Handle Set

- Size - 205mm
- CTC - 57mm
- Material - Zinc
- Finish - Antique
- Lock body 40*57mm - 2mm thick
- Back Set - 40mm
- CTC - 57mm
- Material - SS304
- Finish - Antique
- Key - 2nos
- Door Thickness - 30 to 40mm
- Euro Profile cylinder not required
- Application Wooden & Framed Door



MRP:- 2290/-

HMS-7172-KY/SS

Features:

Plate Handle Set

- Size - 205mm
- CTC - 57mm
- Material - Zinc
- Finish - CP/MATT
- Lock body 40*57mm - 2mm thick
- Back Set - 40mm
- CTC - 57mm
- Material - SS304
- Finish - CP/MATT
- Key - 2nos
- Door Thickness - 30 to 40mm

Application Wooden & Framed Door

Euro Profile cylinder not required

MRP:- 2090/-



HMS-7173-KY-AN

Features:

Plate Handle Set

- Size - 200mm
- CTC - 57mm
- Material - Zinc
- Finish - Antique
- Lock body 40*57mm - 2mm thick
- Back Set - 40mm
- CTC - 57mm
- Material - SS304
- Finish - Antique
- Key - 2nos
- Door Thickness - 30 to 40mm

Application Wooden & Framed Door

Euro Profile cylinder not required

MRP:- 2290/-



HMH-7101-SSS

MORTISE HANDLE

Features:

- Round handle with round pipe
- Supplied in pairs
- Assemble with mortise lock and euro profile cylinder
- Fine finish with superior grip on handle.

MRP:- 1545/-



HMH-7102-SSS

MORTISE HANDLE

Features:

- Round handle with round pipe
- Supplied in pairs
- Assemble with mortise lock and euro profile cylinder
- Fine finish with superior grip on handle.

MRP:- 1450/-



HMH-7103-SSS

MORTISE HANDLE

Features:

- Round handle with round pipe
- Supplied in pairs
- Assemble with mortise lock and euro profile cylinder
- Fine finish with superior grip on handle.

MRP:- 1380/-



HMH-7104-SSS

MORTISE HANDLE

Features:

- Oval handle with round pipe
- Supplied in pairs
- Assemble with mortise lock and euro profile cylinder
- Fine finish with superior grip on handle.

MRP:- 1405/-

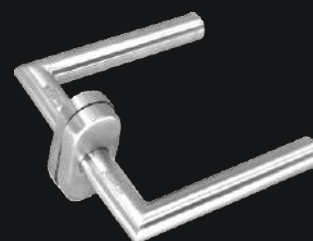

HMH-7105-SSS

MORTISE HANDLE

Features:

- Oval handle with round pipe
- Supplied in pairs
- Assemble with mortise lock and euro profile cylinder
- Fine finish with superior grip on handle.

MRP:- 1650/-



HMC-7131

Both Side Key Cylinder 60mm

Features:

- Both side key application secure key. with five regular key.
- Assemble with mortise handle mortise lock body.
- Provides Locking Solution for wooden & framed door.
- Useful only for single wooden & framed door
- Material - Brass

MRP:- 910/-

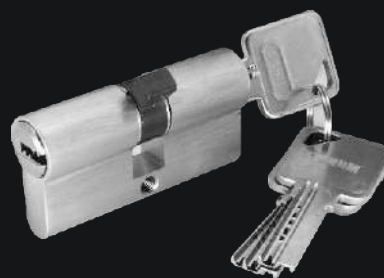

HMC-7132

Both Side Key Cylinder 70mm

Features:

- For one side Key and one side knob application with secure key.
- Assemble with mortise handle mortise lock body.
- Provides Locking Solution for wooden door.
- Useful only for single wooden door.
- Material - Brass

MRP:- 940/-

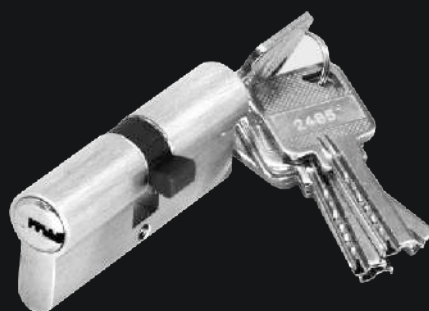

HMC-7133

One Side Key One Side Knob Cylinder 60mm

Features:

- For one side Key and one side knob application with secure key.
- Assemble with mortise handle mortise lock body.
- Provides Locking Solution for wooden door.
- Useful only for single wooden door.
- Material - Brass

MRP:- 1070/-



HMC-7134

One Side Key One Side Knob Cylinder 70mm

Features:

- For one side Key and one side knob application with secure key.
- Assemble with mortise handle mortised lock body.
- Provides Locking Solution for wooden door.
- Useful only for single wooden door.
- Material - Brass

MRP:- 1110/-



HMC-7135

Coin Type Cylinder 60mm

Features:

- One side knob application for one side Locking Solution.
- Suitable only for bathroom type door
- Assemble with Mortise Handle and mortised lock body.
- Provides locking solution for wooden door.
- Useful only for single wooden door
- Material - Brass.

MRP:- 785/-

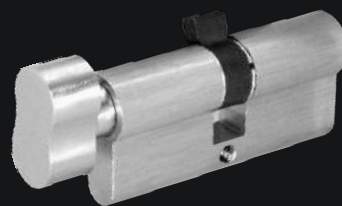

HMC-7136

Coin Type Cylinder 70mm

Features:

- One side knob application for one side Locking Solution.
- Suitable only for bathroom type door
- Assemble with Mortise Handle and Mortised lock body.
- Provides locking solution for wooden door.
- Useful only for single wooden door
- Material - Brass.

MRP:- 880/-

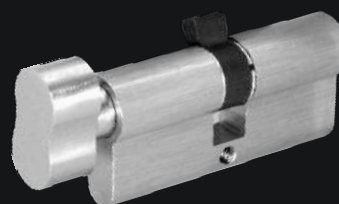

HMC-7137

One Side Key One Side Knob Cylinder 80mm

Features:

- For one side Key and one side knob application with secure key.
- Assemble with mortise handle mortised lock body.
- Provides Locking Solution for wooden door.
- Useful only for single wooden door.
- Material - Brass

MRP:- 1230/-



HML-7151

Mortise Dead Lock for Wooden Door Fitting

Mortise lock body with dead bolt for wooden door

- Finish :- SSS
- Grade :- SS304

MRP:- 1135/-



HML-7152

50*85mm Lock Body

Mortise lock body with latch bolt & dead Bolt for Wooden Door

- Finish :- SSS
- Grade :- SS304

MRP:- 1405/-



HML-7153

60*85mm Lock Body

Mortise Lock Body with latch Bolt & dead Bolt for Wooden Door

- Finish :- SSS
- Grade :- SS304

MRP:- 1350/-

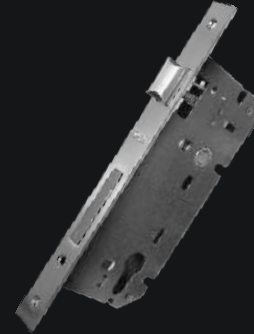

HML-7154

50*85mm Lock Body

Mortise Lock Body with latch Bolt & dead Bolt for Wooden Door

- Finish :- SSS

MRP:- 845/-



HML-7156

30*85mm Lock Body

Mortise Lock Body with latch & dead bolt for wooden & Framed Doors

- Finish :- SSS
- Grade :- SS304

MRP:- 1050/-



HML-7157

30*85mm Dead Lock

Mortise Lock Body with dead bolt for wooden & Framed Doors

- Finish :- SSS
- Grade :- SS304

MRP:- 880/-

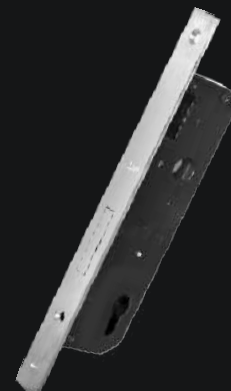

HDA-01

Door Chain

MRP:- 880/-



HDST-01

Door Stopper

Features:

- Rubber Fixed for Glass Safety
- Finish - Stainless Steel
- Material - SS304

MRP:- 240/-



HDST-02

Door Stopper

Features:

Material :- zinc alloy

Finish :- matt

Size :- 5" Inches.



DURABILITY:- Doorstops bottom portion has non-slip three-dimensional curved structure, the door stopper will grip the floor tightly, silent anti-collision.

MRP:- 300/-

HDA-02

Door Eye

- Door Thickness - 35-60mm
- Hole Dia - 17mm
- Angle - 170°

MRP:- 740/-



HNL-001

Night Latch Lock

Primary dead bolt with double throw operated by key from outside key to knob function

Features:

- Door thickness 30-60mm
- Single point dead bolt for security
- Latch lockable by knob from inside
- 3 High Security Computerized dimple Brass Keys
- Finish - powder coated-matt

MRP:- 2650/-



HTDL-001

Accusation indicators for door

Features:

Material -SSS

Finish Matt

Door Thickness-10mm to 30mm

User-friendly Design Red and green color will indicate whether the room is occupied. It can be used for public toilet, restroom and bathroom to indicate that the room is vacant or engaged.

Widely Used It is applicable to public toilets such as airport, station, hospital, shopping mall and office building.

MRP:- 850/-



HTDL-002

Mortise Lock Body

Features:

- Application: Locks & Security Systems
- Single dead bolt with single through 13mm
- Door Thickness : 30mm
- Finish : powder coated

MRP:- 690/-



TOWER BOLTS

Features

- Standard Tower Bolt
- SS-202
- Finish - Satin



HTB-4-SS	4" Standard Tower Bolt	MRP:- 130/-
HTB-6-SS	6" Standard Tower Bolt	MRP:- 190/-
HTB-8-SS	8" Standard Tower Bolt	MRP:- 250/-
HTB-10-SS	10" Standard Tower Bolt	MRP:- 310/-
HTB-12-SS	12" Standard Tower Bolt	MRP:- 370/-

BUTT HINGES



4 Ball Bearing Butt Hinges

HBH-4BB-4x3x2.5 mm **MRP:- 350/-**

HBH-4BB-4x3x3.0 mm **MRP:- 445/-**

HBH-4BB-5x3x3.0 mm **MRP:- 470/-**



2 Ball Bearing Butt Hinges

HBH-2BB-4x3x2.5 mm **MRP:- 330/-**

HBH-2BB-4x3x3.0 mm **MRP:- 360/-**

HBH-2BB-5x3x3.0 mm **MRP:- 430/-**



Non Ball Bearing Butt Hinges

HBH-NBB-4x2.5x2.5 mm **MRP:- 150/-**

HBH-NBB-3x2.5x2.5 mm **MRP:- 120/-**

HBH-NBB-5x2.5x2.5 mm **MRP:- 190/-**



Fire Rated Butt Hinges

HBH-2BB-4x3x3 mm - F

MRP:- 410/-



Fire Rated Flap Hinges

HBH-FP-5x3x3 mm - F

MRP:- 430/-



WOODEN SLIDING FOLDING SYSTEM



Features

- Track - Anodized Aluminum
- Track - 3600/4800 mm
- Max Panel Width - 800mm
- Max Panel Weight - 50 Kg
- Max Height - 2400mm

HDSL-201-W

Top & Bottom Pivot

MRP:- 5500/-

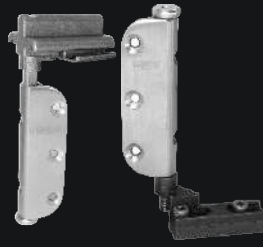

HDSL-202-W

Panel to Panel
Connecting Hinge With Handle

MRP:- 4500/-



HDSL-203-W

Hinges With Intermediate Roller
With Bottom Guide

MRP:- 9500/-

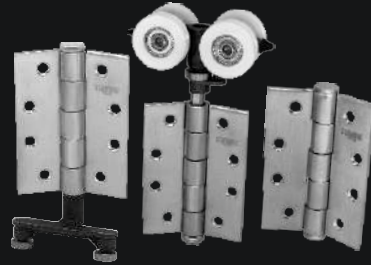

HDSL-204-W

End Roller with Bottom Guide

MRP:- 7500/-



HDSL-ACC-002-S

Wooden Sliding Door Lock

- Door Thickness - 35 mm
- Material - Alloy

MRP:- 3300/-



HDSL-TT

Top Track

(Available -3600mm / 4800 mm)

12 ft. :- MRP:- 10000/-

16 ft. :- MRP:- 12000/-

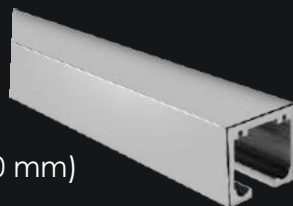

HDSL-BT

Bottom Track

(Available -3600mm / 4800 mm)

12 ft. :- MRP:- 7000/-

16 ft. :- MRP:- 9000/-

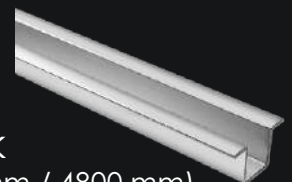

SLIDING DOOR'S

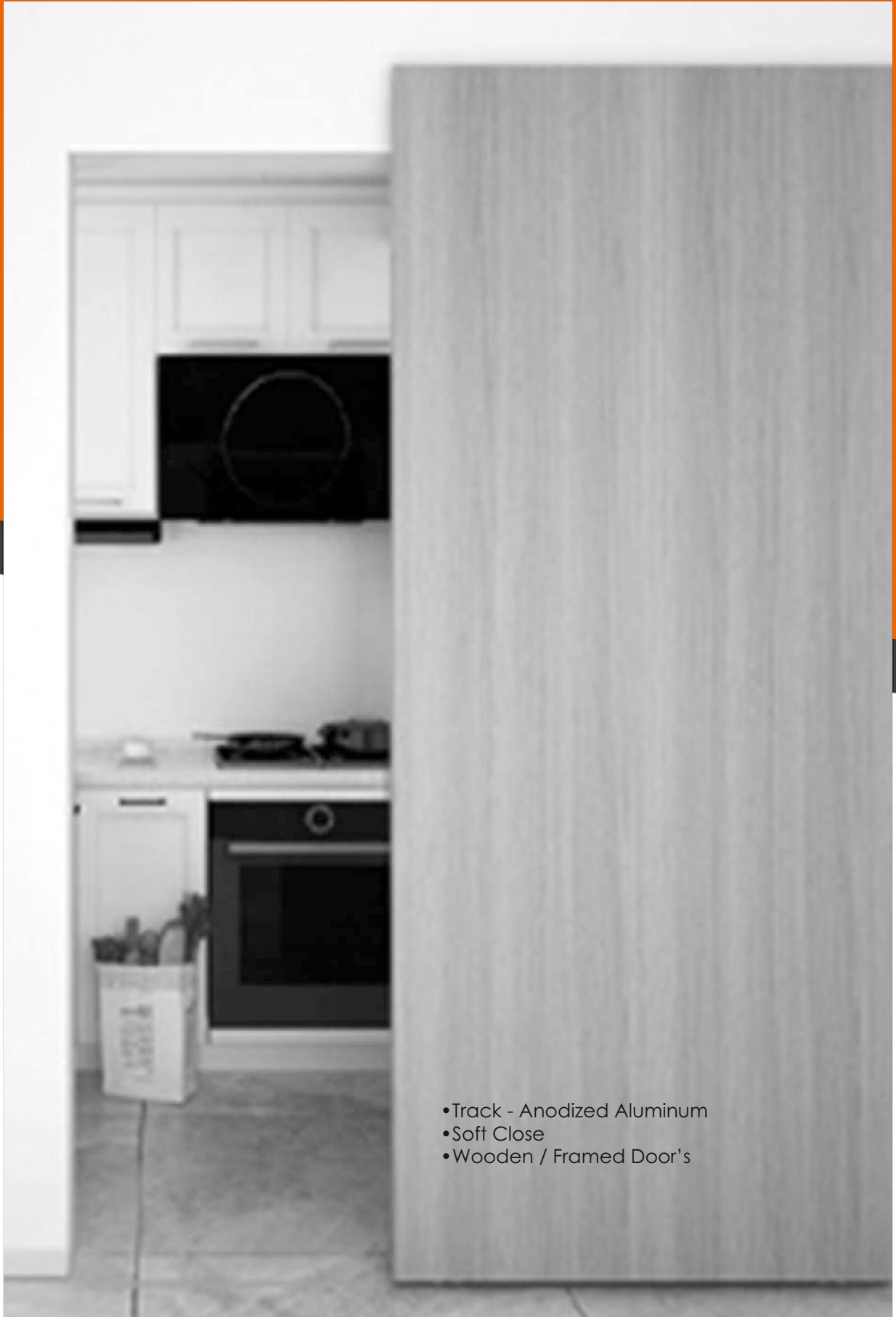

- Track - Anodized Aluminum
- Soft Close
- Wooden / Framed Door's

**SLIDING DOOR ROLLER
HDSL-301-W**

Maximum Door Width : 1000mm
 Maximum Door Height : 2400mm
 Weight : 40-80kg
 Length : 2 mtr.
 Track Material : Aluminium anodizing
 Door thickness : 40mm (Minimum)

MRP:- 5650/-

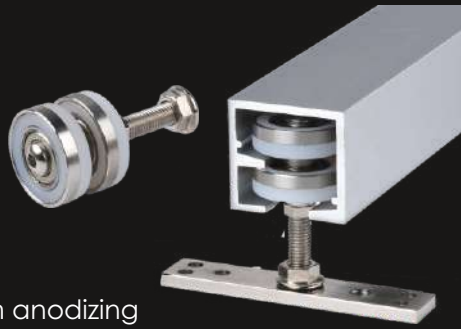

HDSL-301-W-Track

MRP:- 4600/-



**SLIDING DOOR ROLLER
HDSL-302-W**

Maximum Door width : 1000mm
 Maximum Door Height : 2400mm
 Weight : 80kg
 Length : 2 mtr.
 Door thickness : 30-60mm

MRP:- 5200/-



HDSL-302-W-Track

MRP:- 3250/-

**SLIDING DOOR ROLLER
HDSL-303-W**

Maximum Door width : 800mm
 Maximum Door Height : 2100mm
 Weight : 60kg
 Length : 2 mtr.
 Door thickness : 30-45mm

MRP:- 7650/-



HDSL-303-W-Track

MRP:- 5950/-

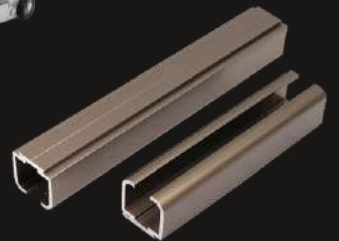

**SLIDING DOOR ROLLER
HDSL-304-W**

Maximum Door width : 800mm
 Maximum Door Height : 2100mm
 Weight : 60kg
 Length : 2 mtr.
 Door thickness : 35-50mm

MRP:- 7900/-

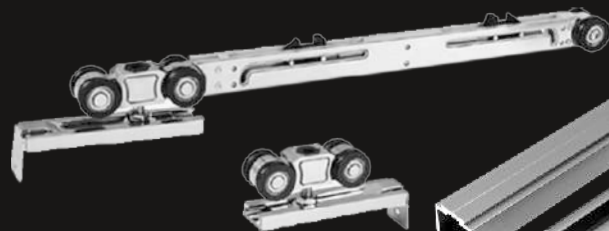

HDSL-304-W-Track

MRP:- 5950/-

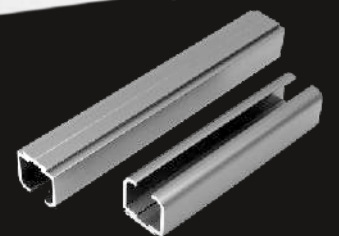

**SLIDING DOOR ROLLER
HDSL-305-W**

Maximum Door Width : 800mm
 Maximum Door Height : 2400mm
 Weight : 50-60kg
 Length : 1.21 mtr.
 Track Material : Aluminium anodizing
 Door thickness : 40-50mm

MRP:- 48600/-



HDSL-305-W-Track



SLIDING DOOR ROLLER HDSL-306-W

- Synchronized soft closing system for 2 doors,
- one side opening,
- Door thickness : 30-50mm.
- Door Fan width : 735-1200mm
- Finish : Nickel ,
- Door weight : 80kg s/door

MRP:- 21650/-

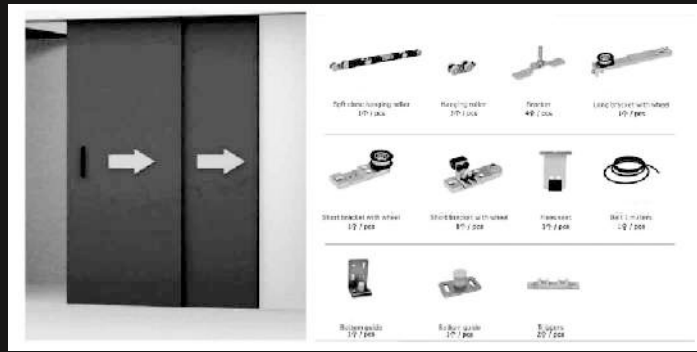

SLIDING DOOR ROLLER HDSL-307-W

- Synchronized soft closing system for 3 doors,
- one side opening,
- Door thickness : 30-50mm.
- Door Fan width : 500-1200mm
- Finish : Nickel ,
- Door weight : 80kg s/door

MRP:- 26550/-



SLIDING DOOR ROLLER HDSL-308-W

- Synchronized inversion soft closing system for 2 doors,
- opposite opening,
- Door thickness : 30-50mm.
- Door Fan width : 500-1200mm
- Finish : Nickel ,
- Door weight : 80kg s/door

MRP:- 19650/-

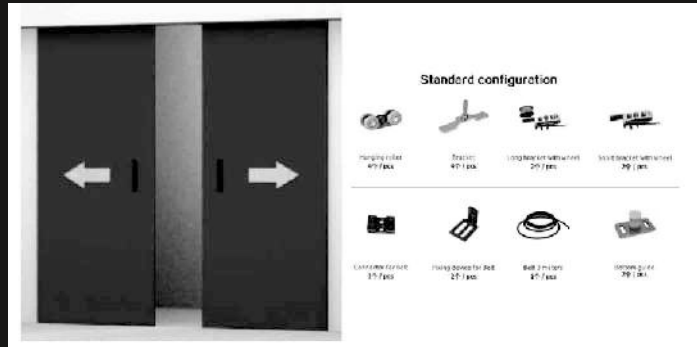

HDSL-ACC-001-S HDSL-ACC-001-G

- Wooden door lock : 160mm
- Suitable door thickness : 30-50mm
- Finish : Silver | Gold

Silver - MRP:- 2250/-

Gold - MRP:- 2450/-

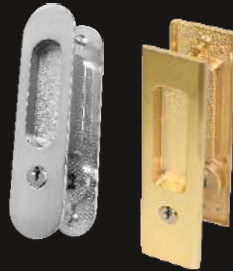

HDSL-ACC-002-S HDSL-ACC-002-G

- Wooden door lock : 180mm
- Suitable door thickness : 30-50mm
- Finish : Silver | Gold

Silver - MRP:- 3300/-

Gold - MRP:- 3600/-

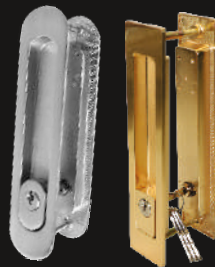

HDSL-ACC-003-S HDSL-ACC-003-G

- Wooden door lock : 180mm
- Suitable door thickness : 30-50mm
- Finish : Silver | Gold

Silver - MRP:- 1600/-

Gold - MRP:- 1900/-



Glass telescopic sliding system

Stanum Manual Glass Telescopic Sliding Door System to achieve maximum clear door opening space. Its glass panels can be stacked on one side in-line with top track and require minimum parking space i.e. minimum space for stacking the panels.

Applications are in residential and commercial interior spaces as internal partitioning system. For more details below.

Features

- Maximum opening space
- Equal stacking to the track with minimum parking space
- Requires no bottom track
- Sliding panels are interlinked

Specification

- Maximum Width of Panels – 1100mm
- Maximum Height of Panels – 2400mm
- Maximum Weight of Panels – 95kg
- Maximum Thickness of Glass – 8/12mm
- Available Track Length – 4mtr
- Finish – Aluminum Anodized
- Available – 2+1 & 3+1 Panels

